

EXPLODED DRAWING A

Model No. 25061.0 R0916A

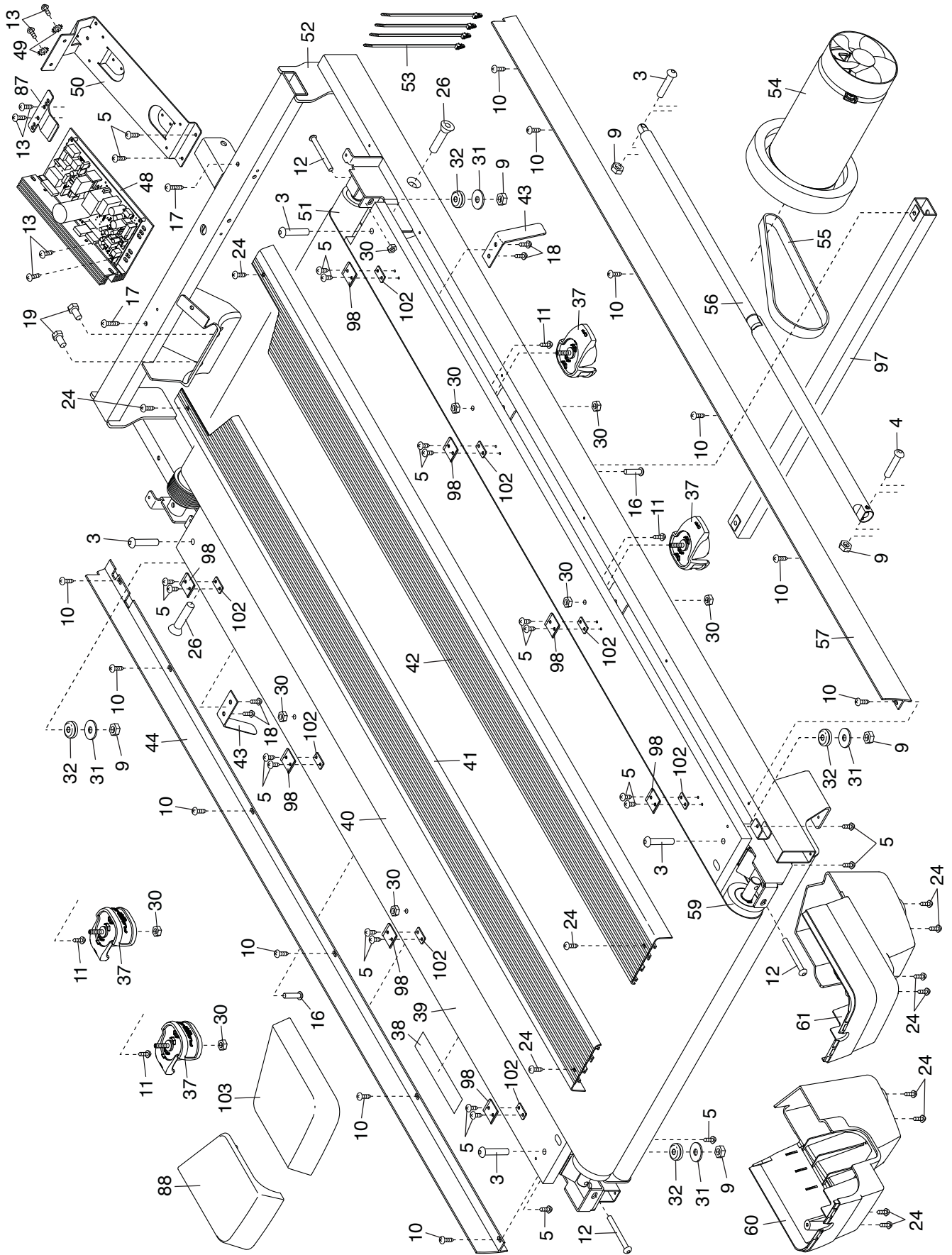

EXPLODED DRAWING B

Model No. 25061.0 R0916A

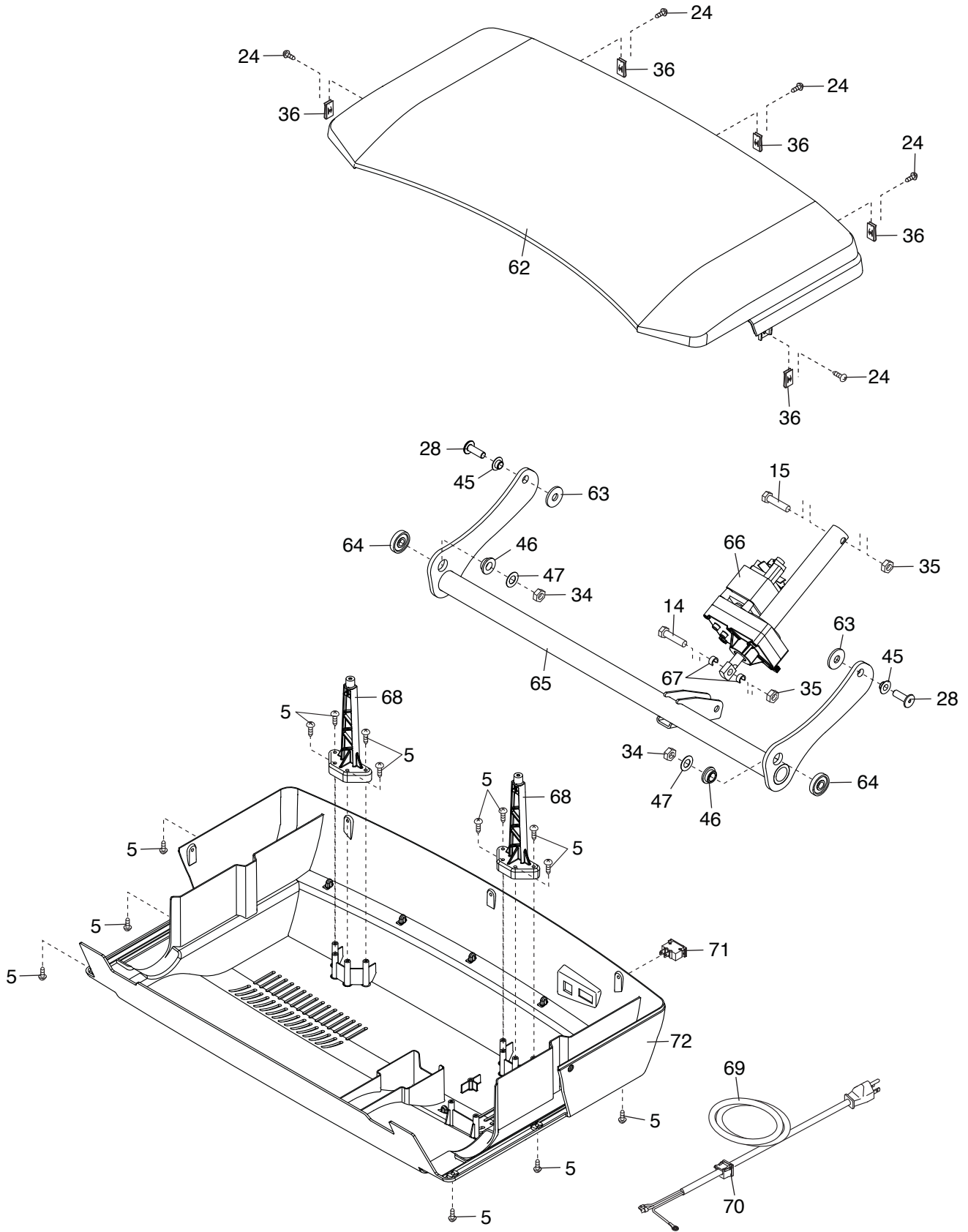

EXPLODED DRAWING C

Model No. 25061.0 R0916A

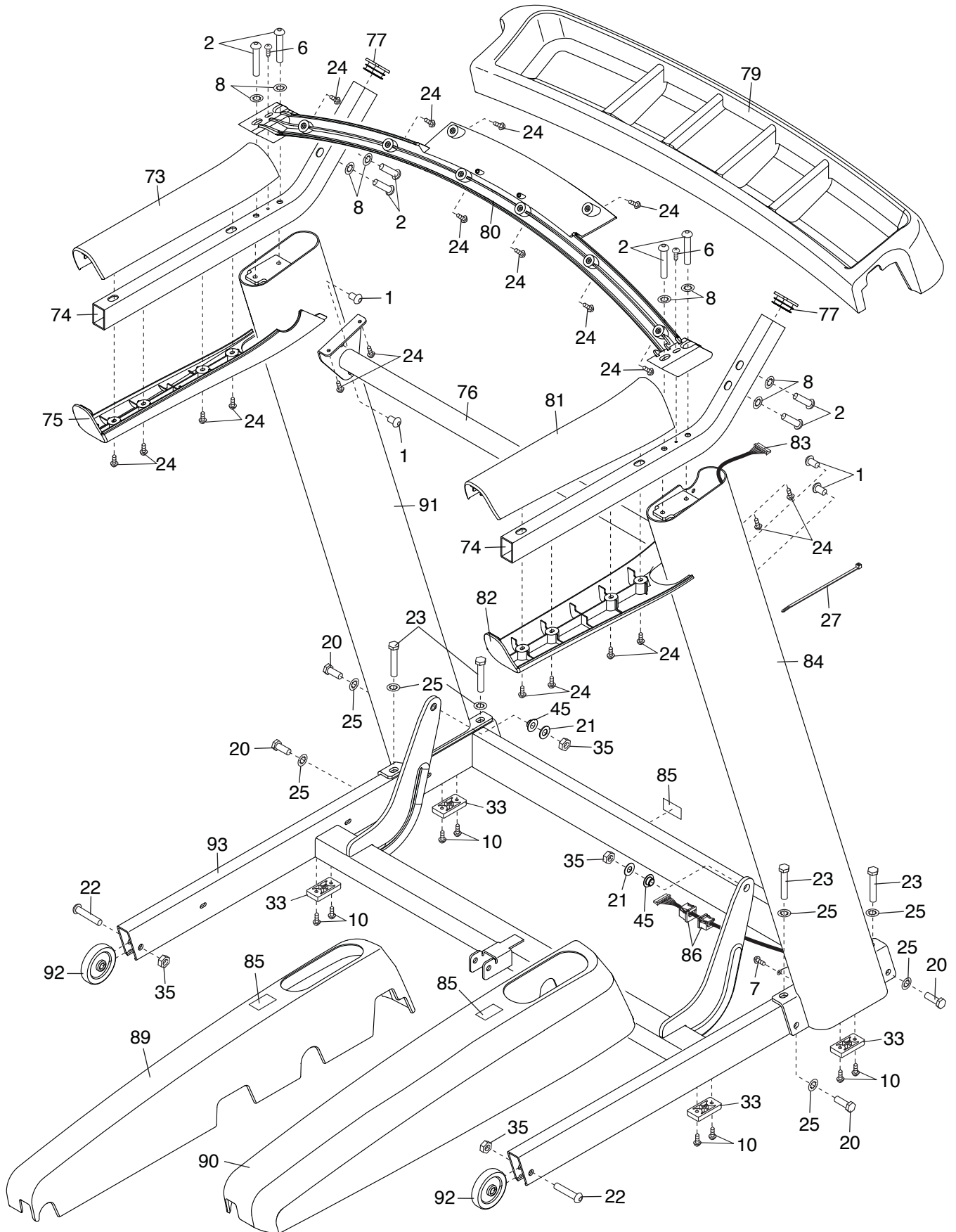

EXPLODED DRAWING D

Model No. 25061.0 R0916A

