

EXPLODED DRAWING- Model No. 831.285063

Rev. 1/92

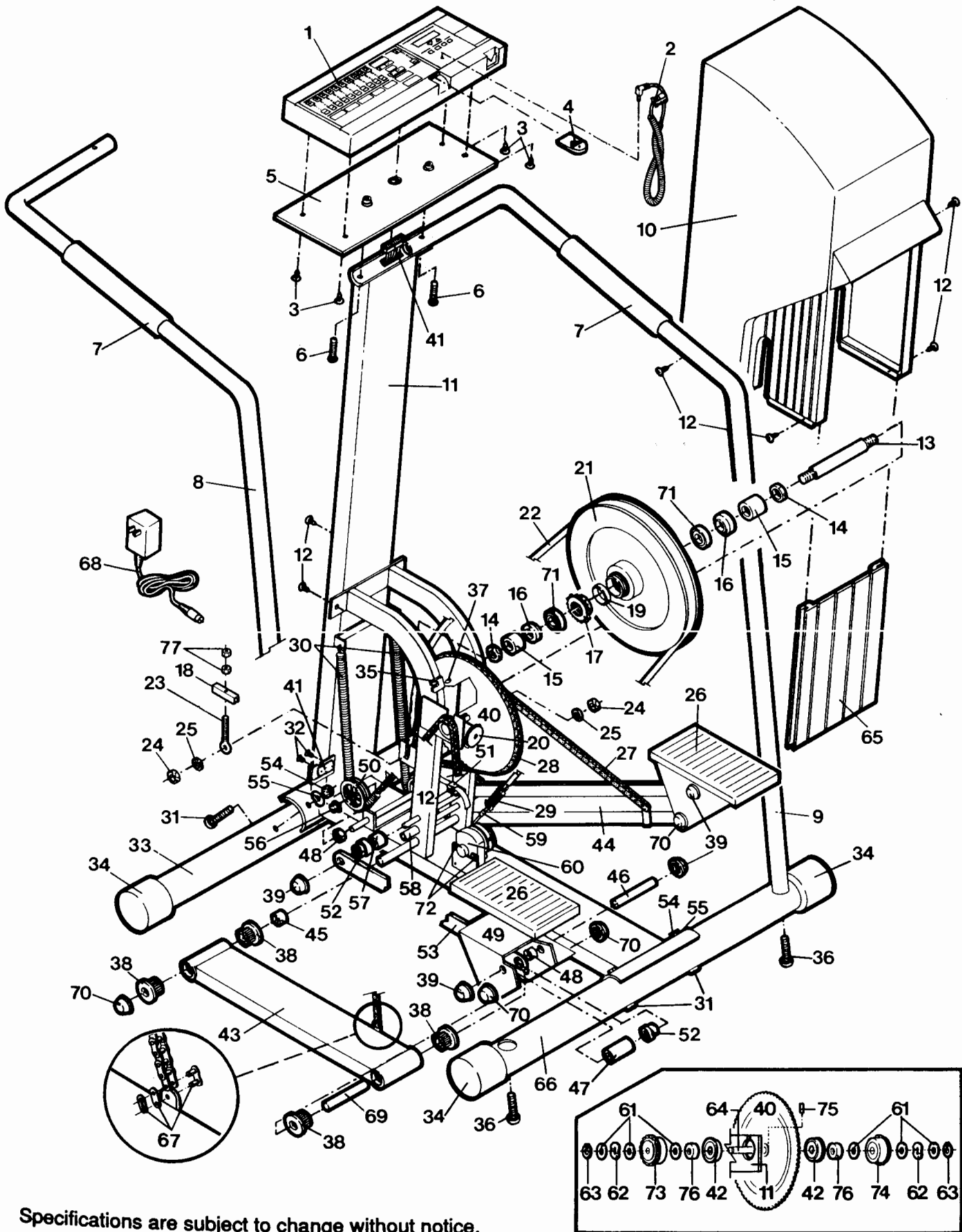

Specifications are subject to change without notice.