

EXPLODED DRAWING—Model No. 831.293062

R0803A

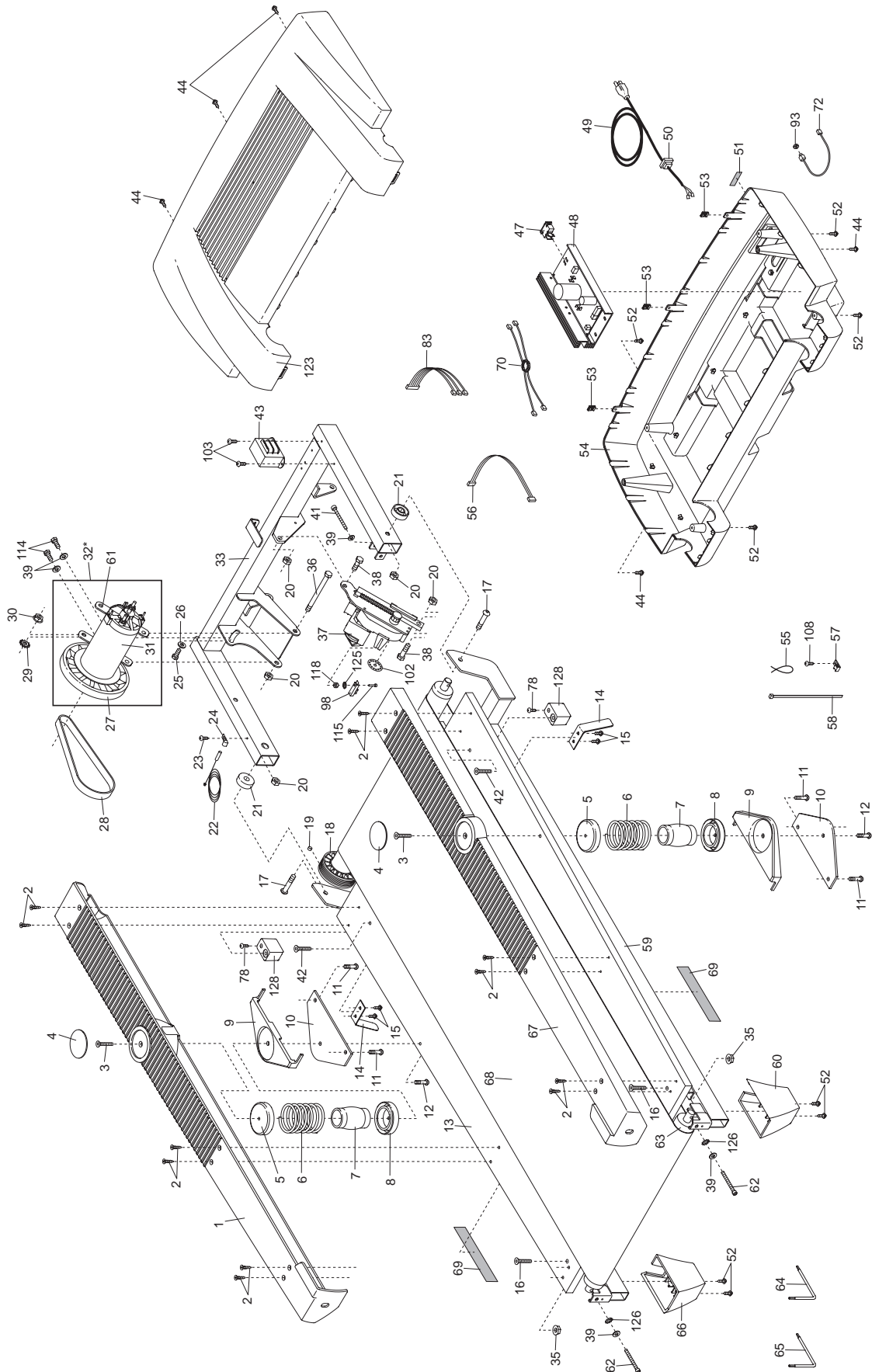

EXPLODED DRAWING—Model No. 831.293062

R0803A

