

EXPLODED DRAWING—Model No. 831.293200

R0303A

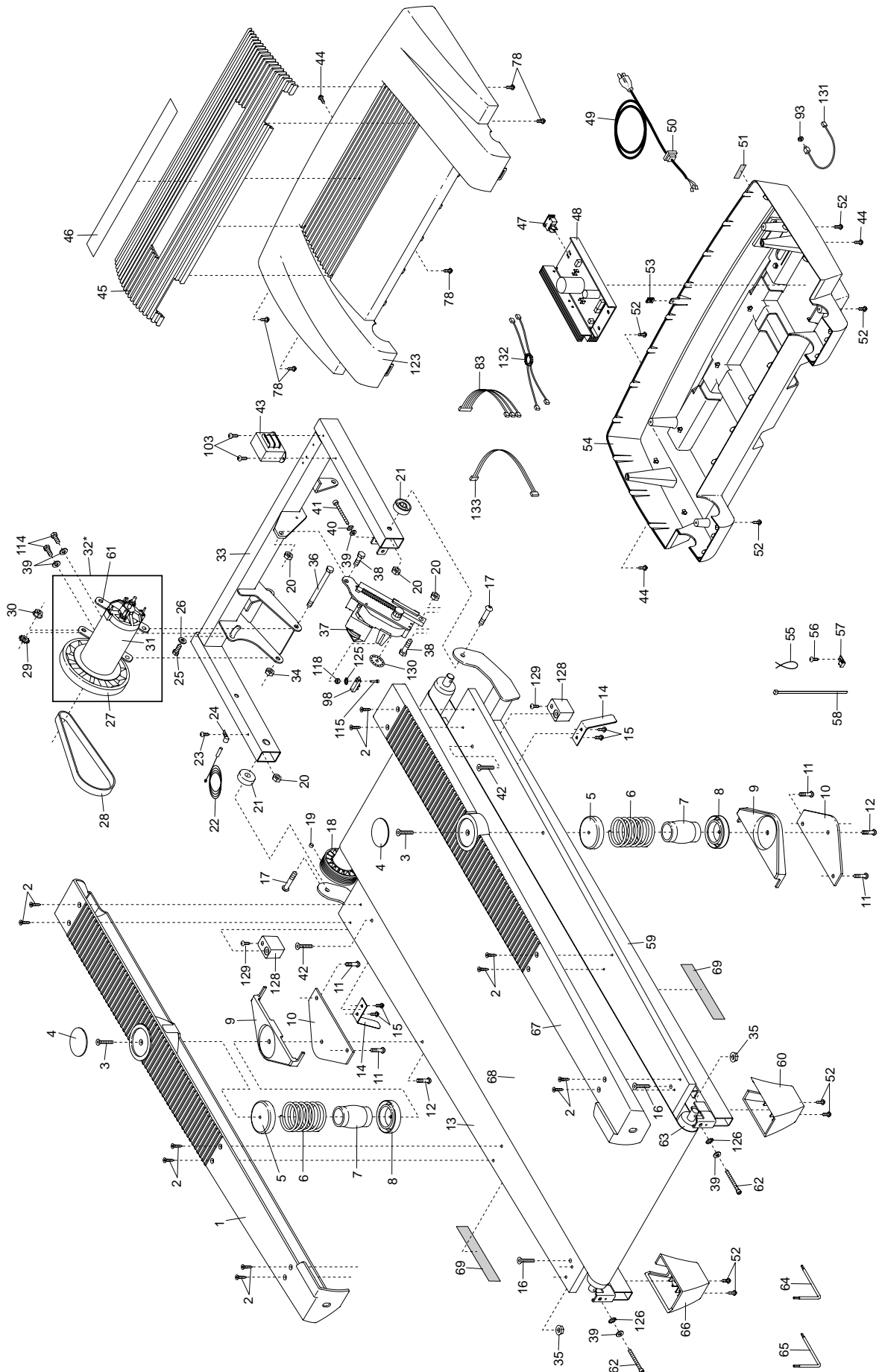

EXPLODED DRAWING—Model No. 831.293200

R0303A

