

EXPLODED DRAWING—Model No. 831.293202

R0803A

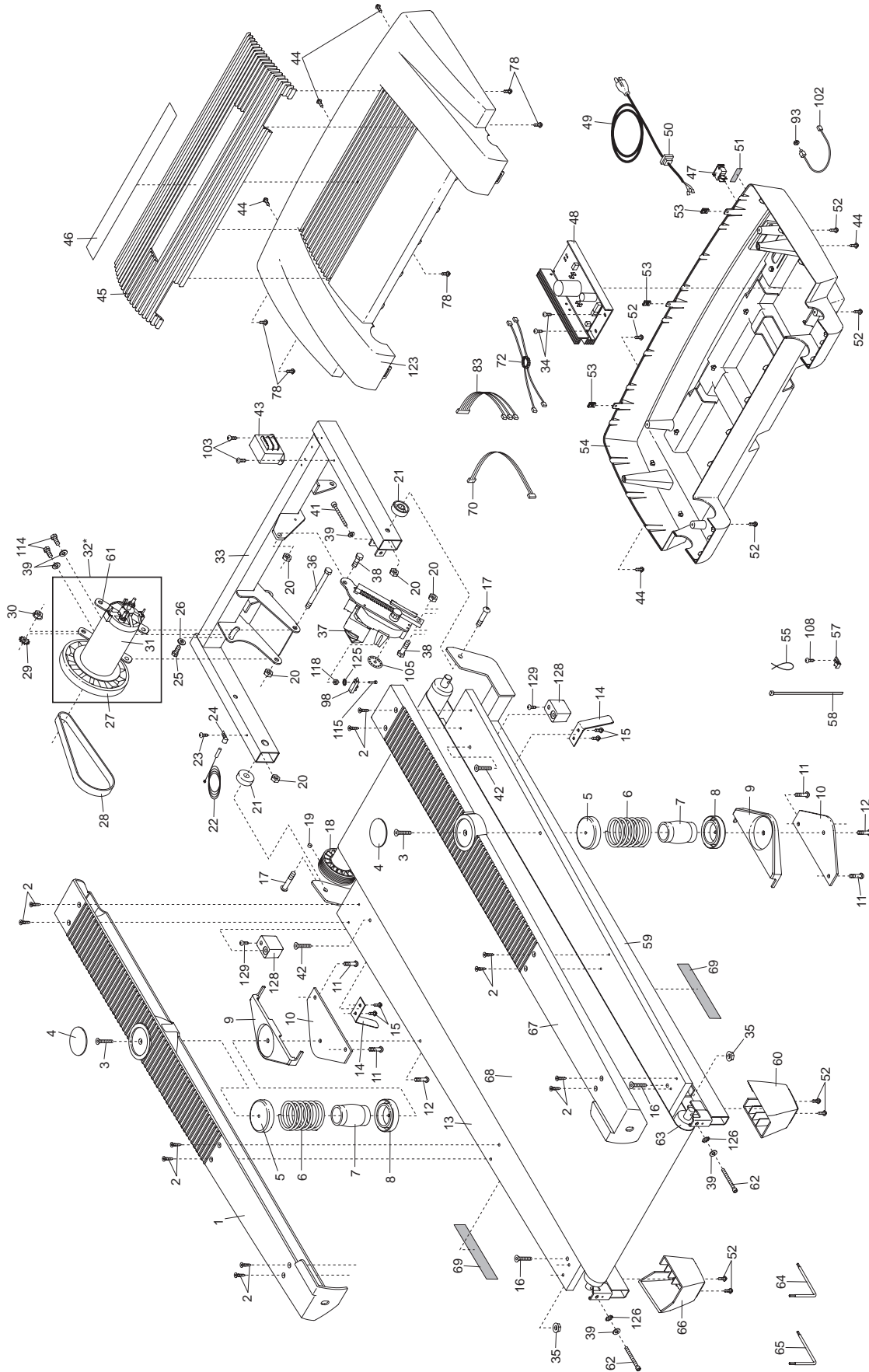

EXPLODED DRAWING—Model No. 831.293202

R0803A

