

EXPLODED DRAWING—Model No. 831.294060

R1003A

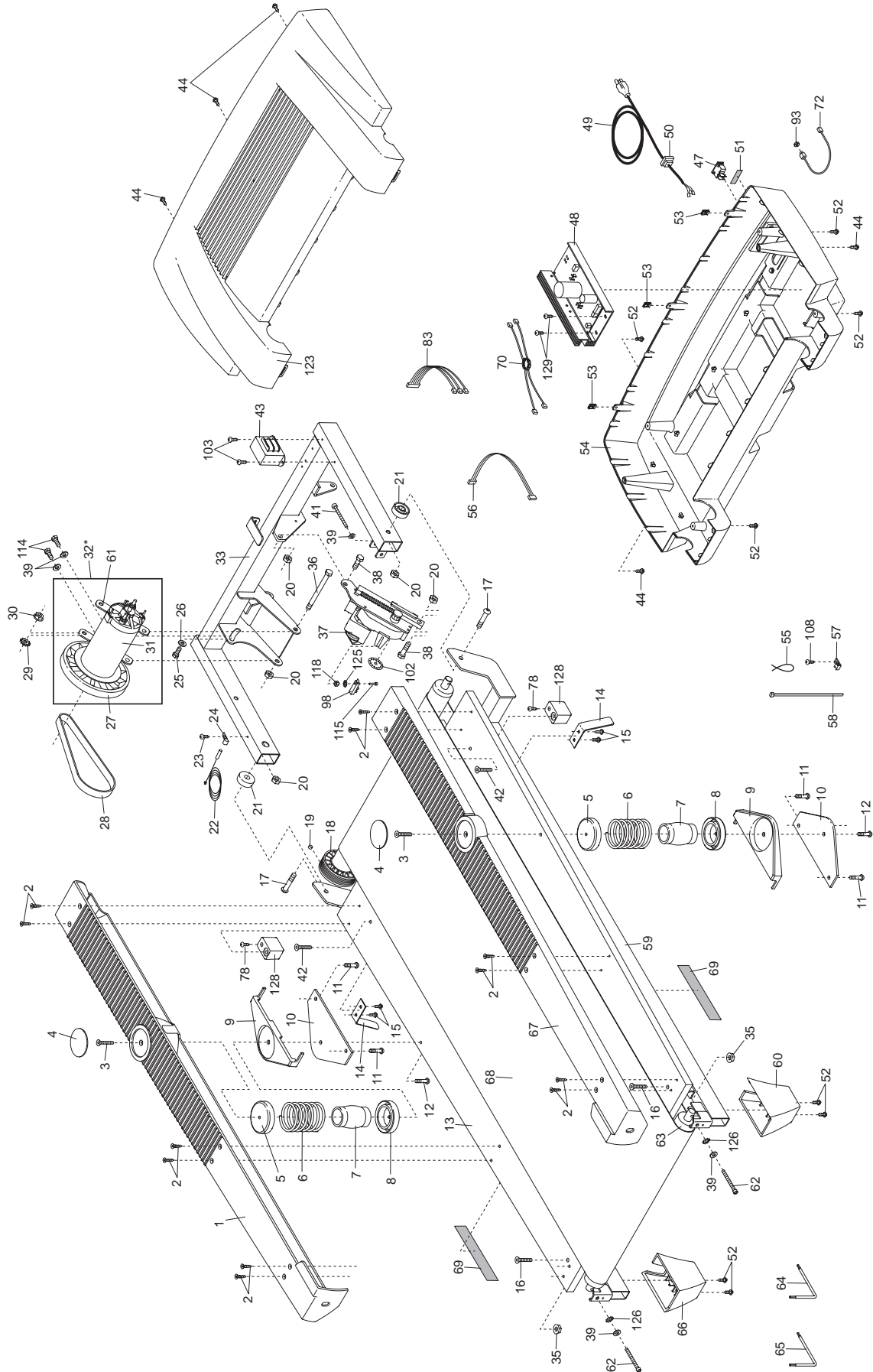

EXPLODED DRAWING—Model No. 831.294060

R1003A

