

# EXPLODED DRAWING—Model No. 831.294250

R1003A

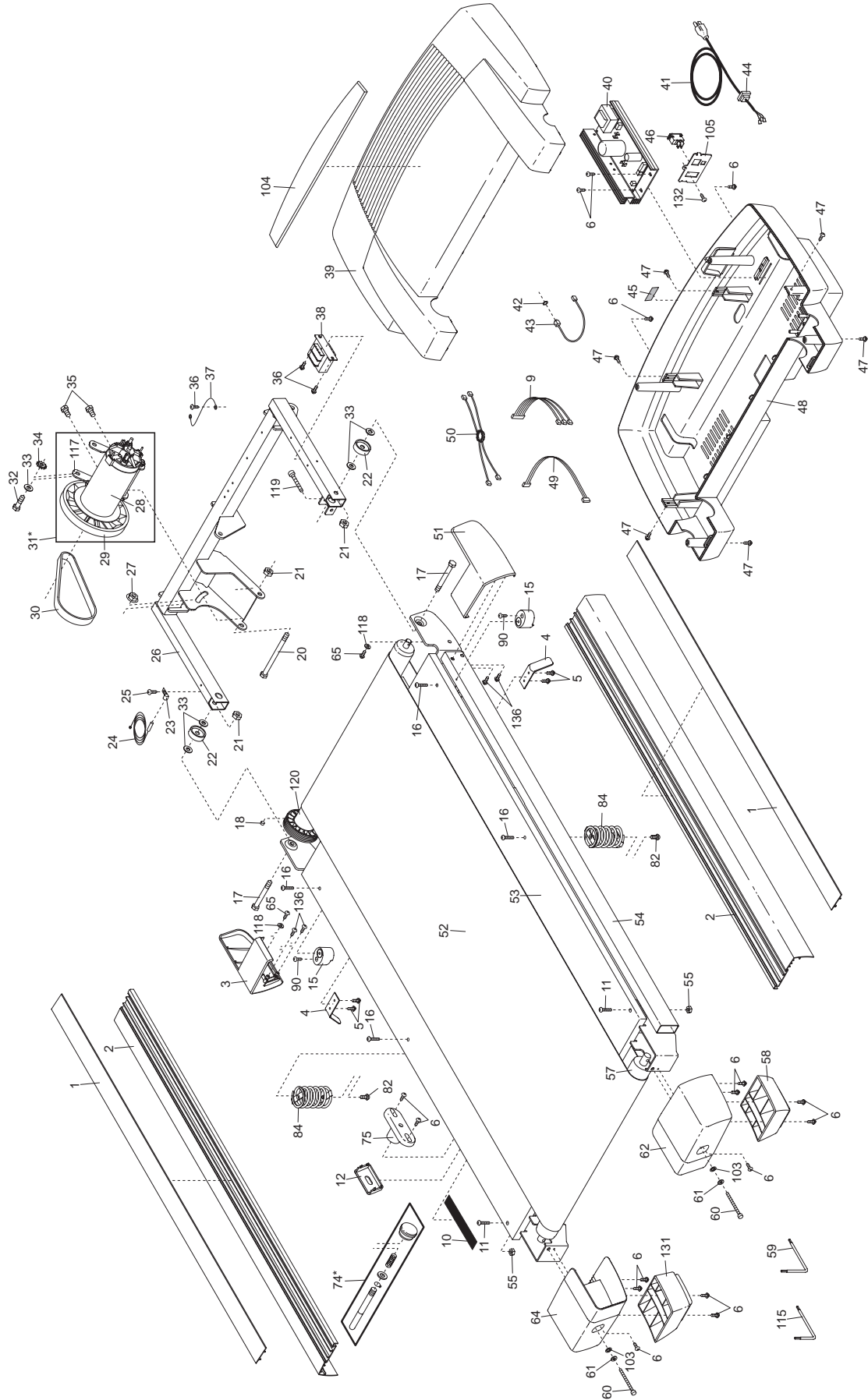

# EXPLODED DRAWING—Model No. 831.294250

R1003A

