

# EXPLODED DRAWING—Model No. 831.294251

R1103A

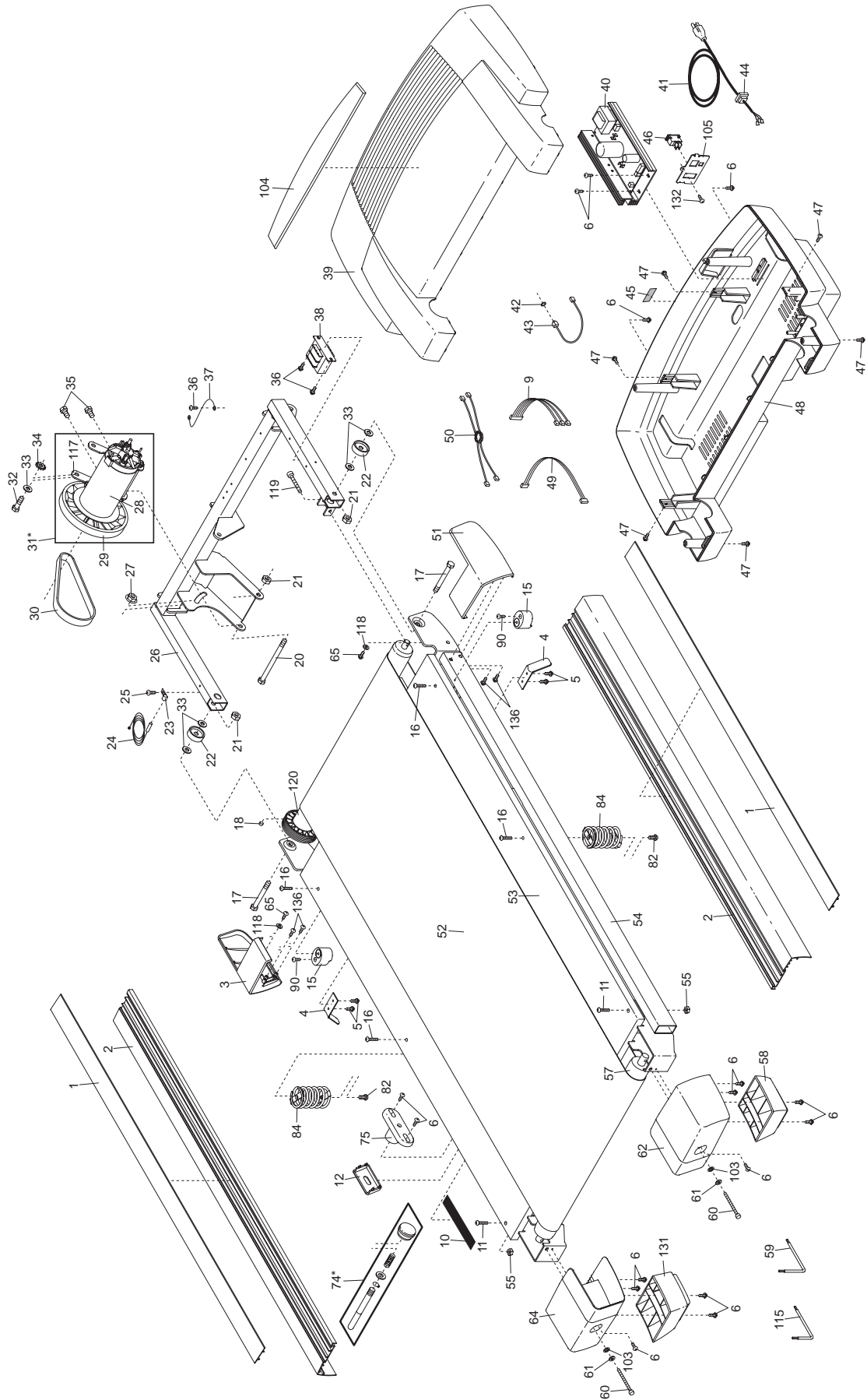

# EXPLODED DRAWING—Model No. 831.294251

R1103A

