

EXPLODED DRAWING—Model No. 831.294252

R0204A

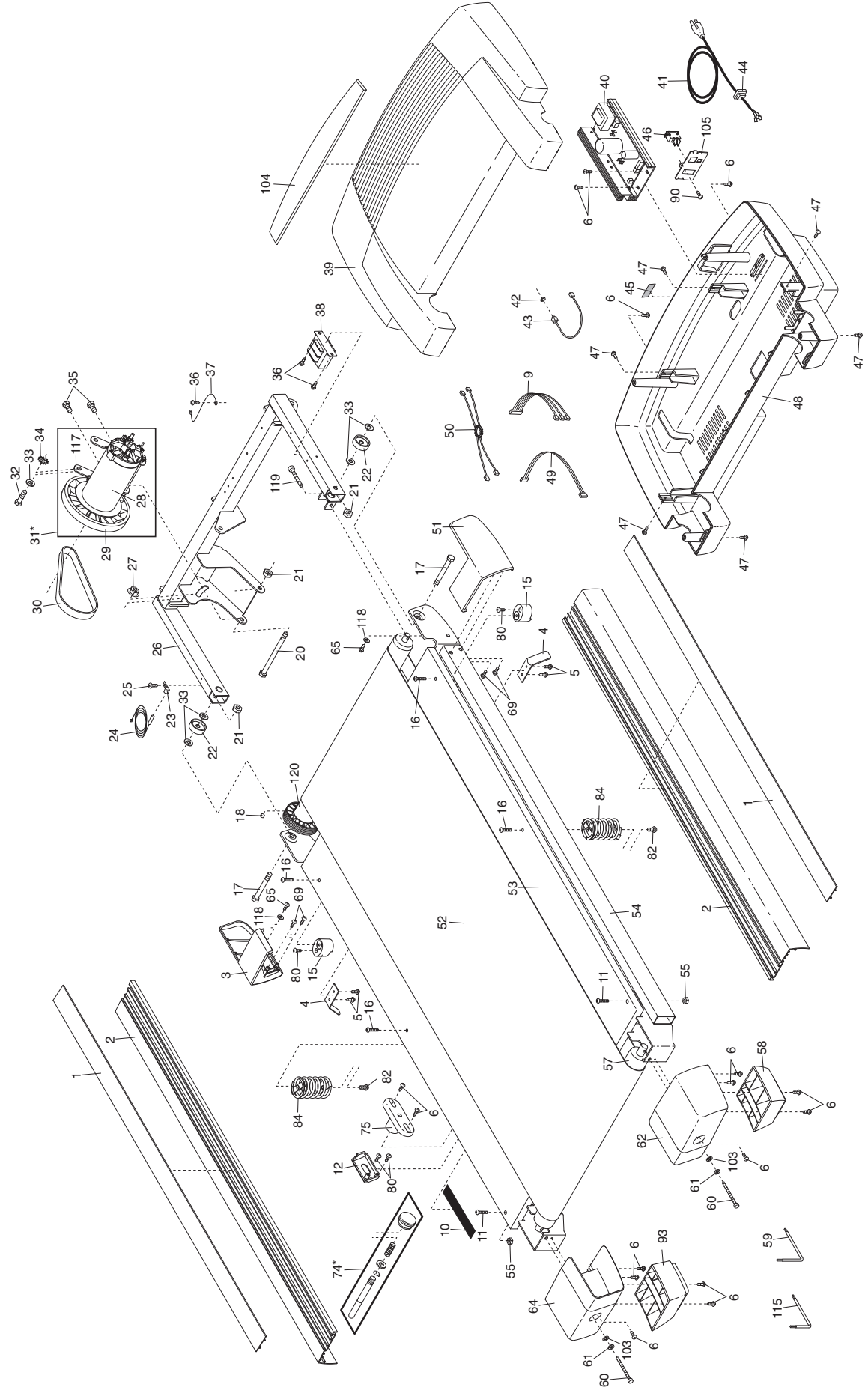

EXPLODED DRAWING—Model No. 831.294252

R0204A

