

EXPLODED DRAWING—Model No. 831.29525.3

R0305A

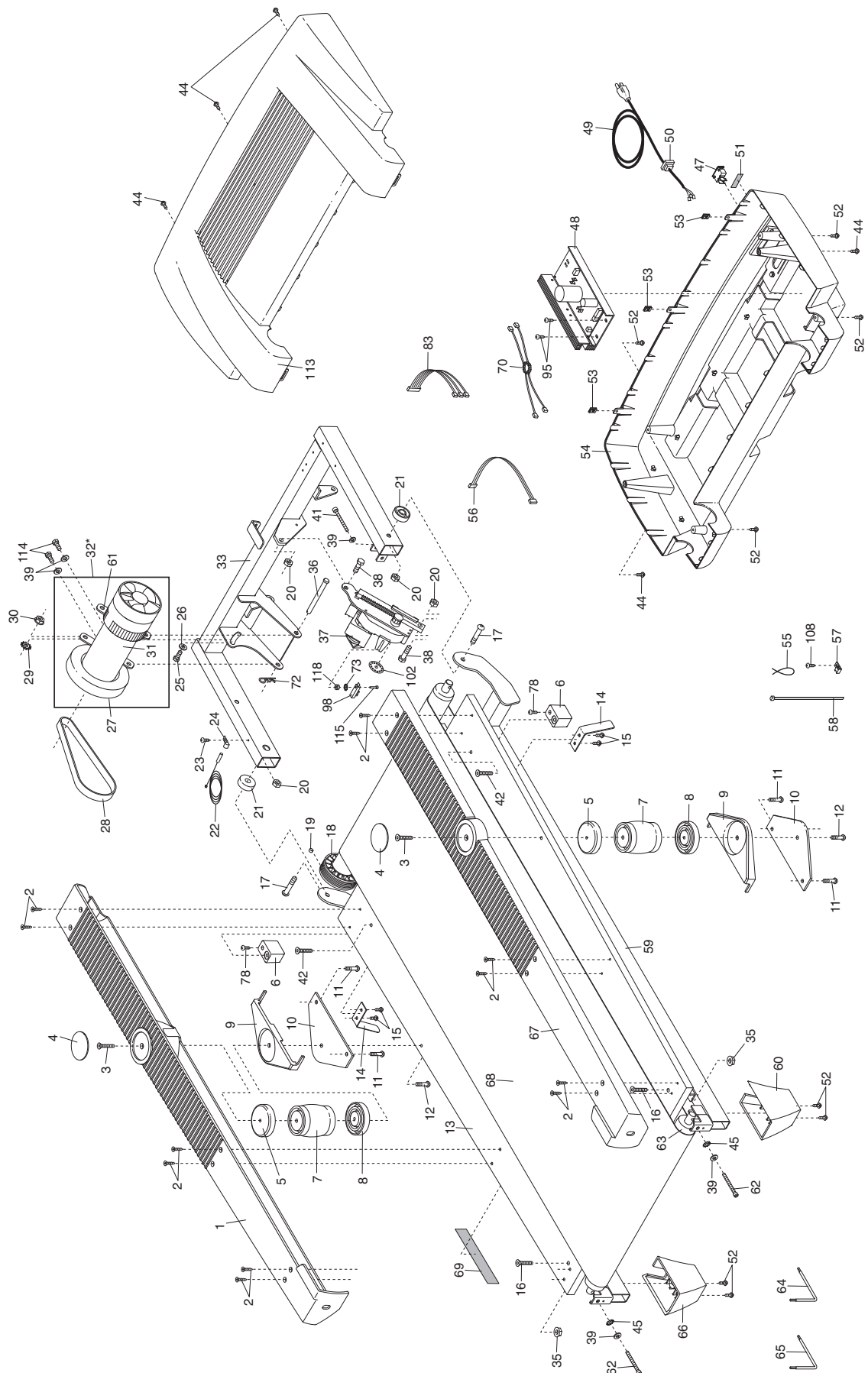

EXPLODED DRAWING—Model No. 831.29525.3

R0305A

