

# EXPLODED DRAWING—Model No. 831.29606.1

R0306A

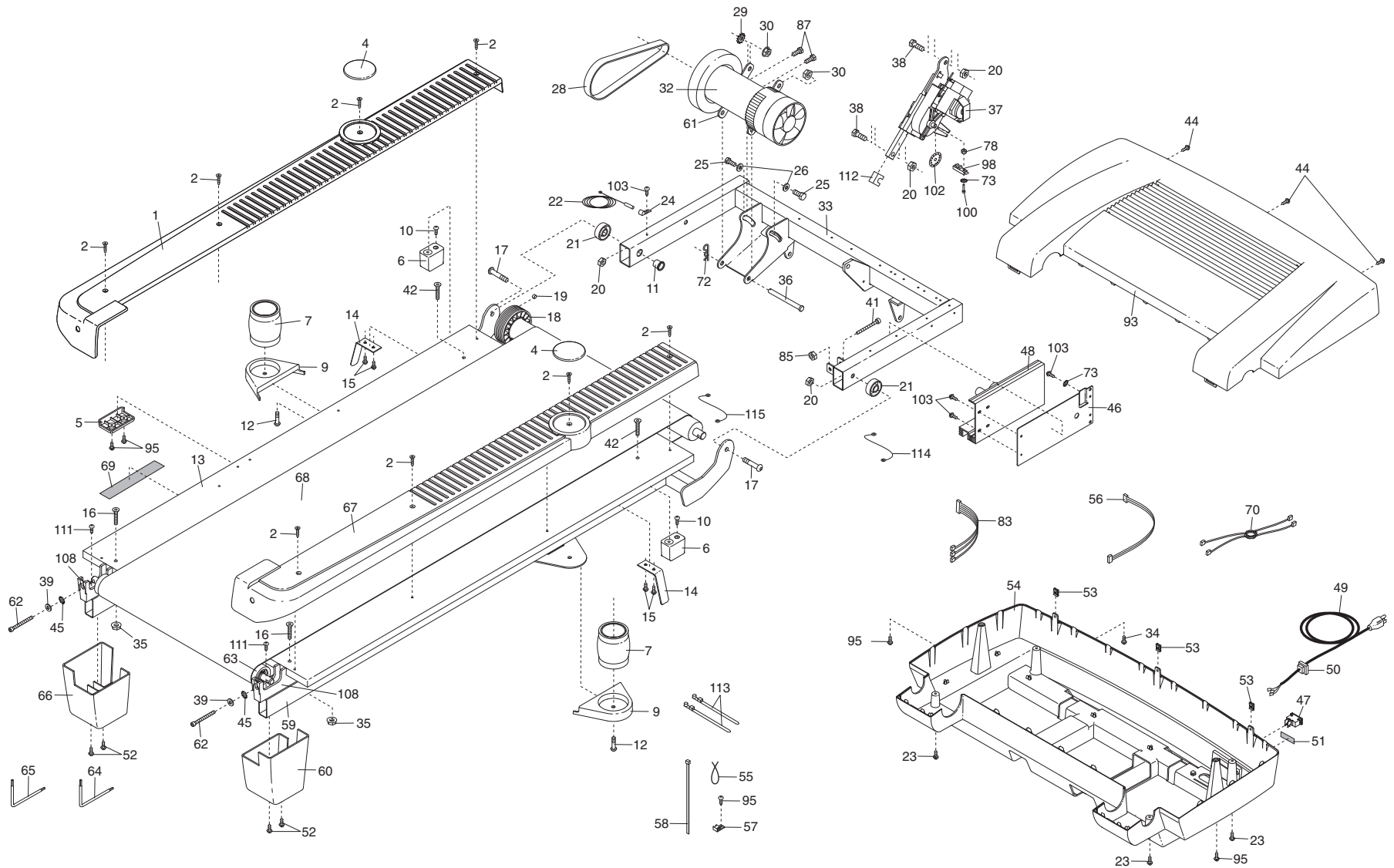

# EXPLODED DRAWING—Model No. 831.29606.1

R0306A

