

EXPLODED DRAWING—Model No. 831.29675.0

R0905A

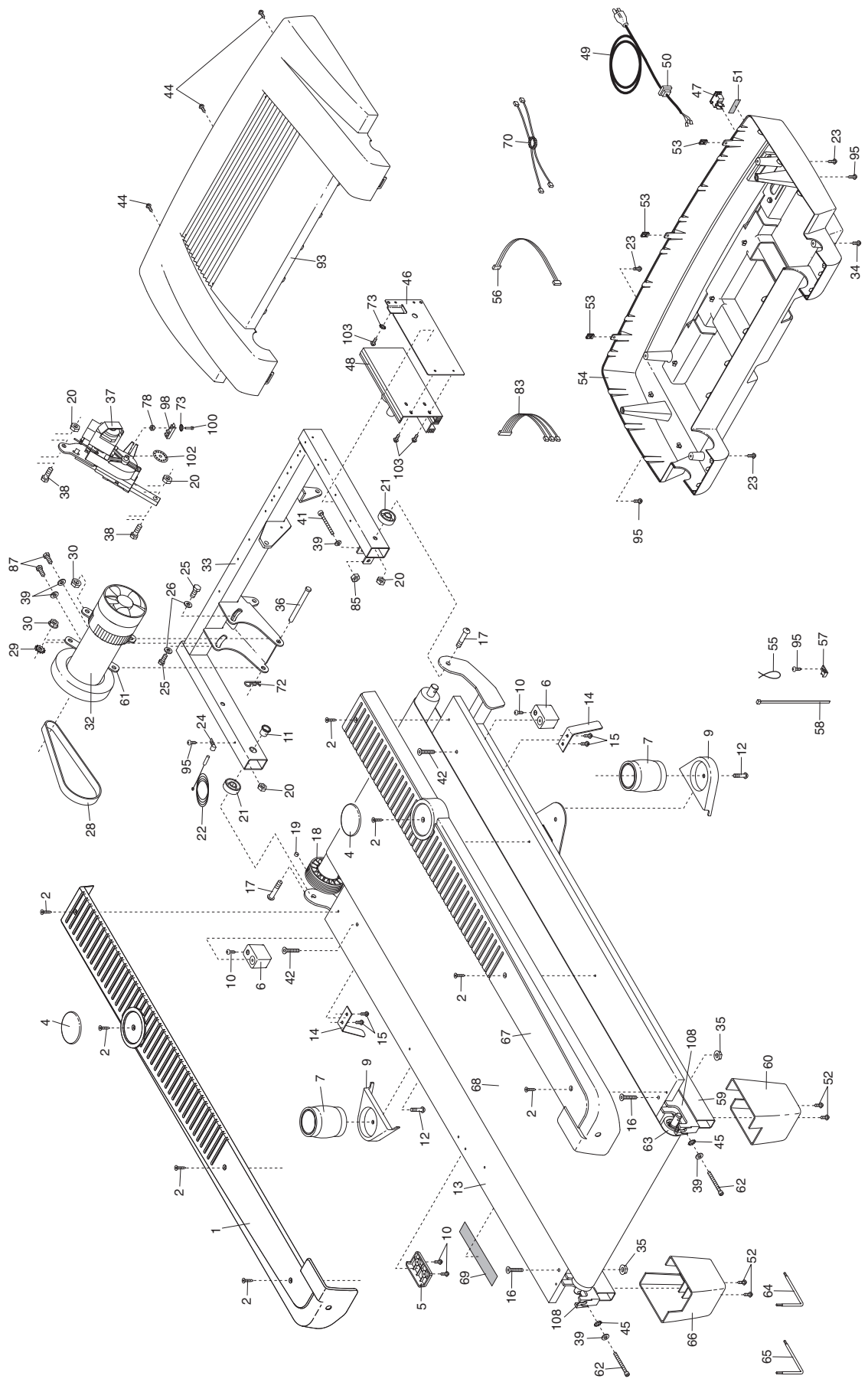

EXPLODED DRAWING—Model No. 831.29675.0

R0905A

