

EXPLODED DRAWING—Model No. 831.29675.1

R0406A

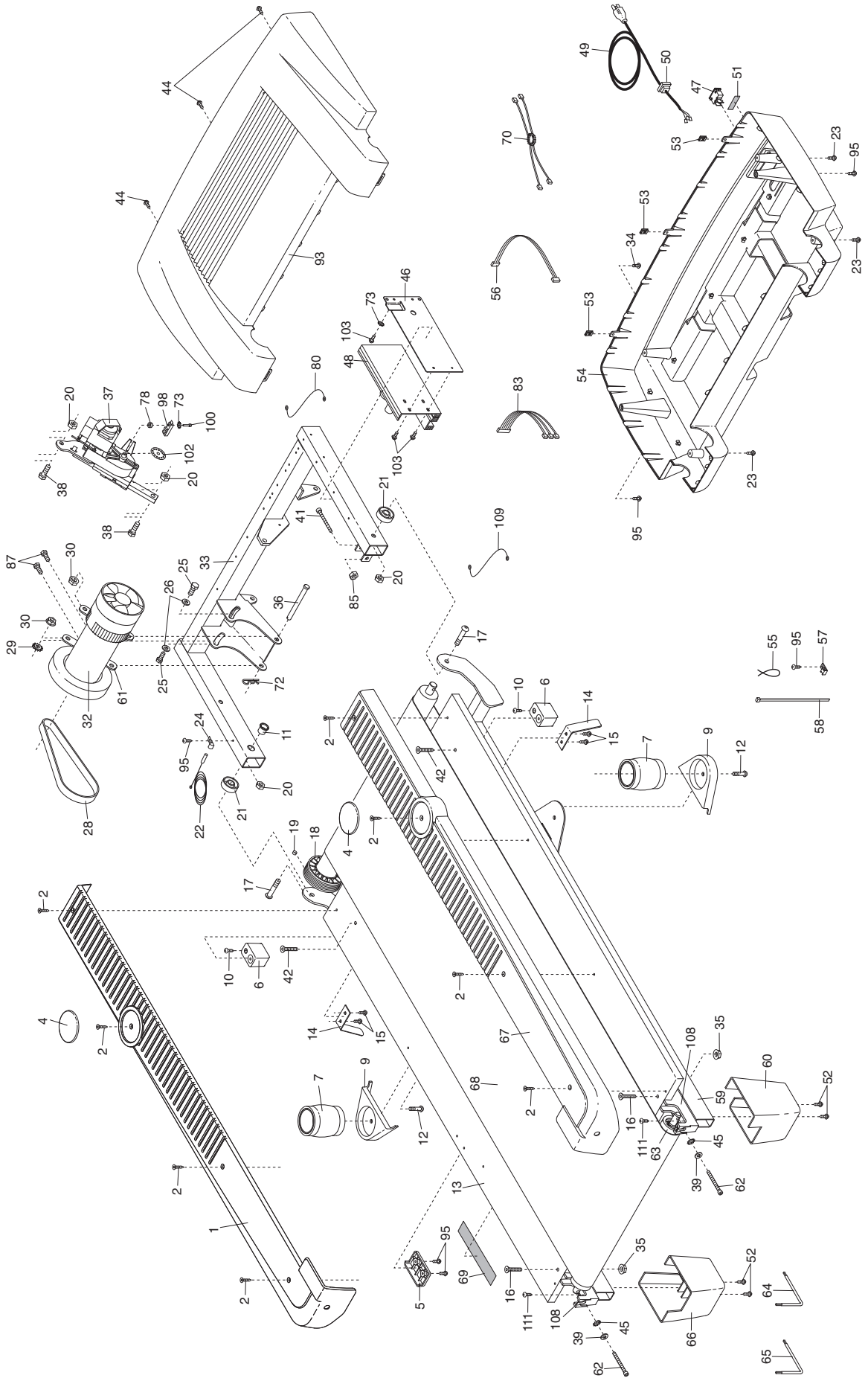

EXPLODED DRAWING—Model No. 831.29675.1

R0406A

