

EXPLODED DRAWING — Model No. 831.297783

R0398A

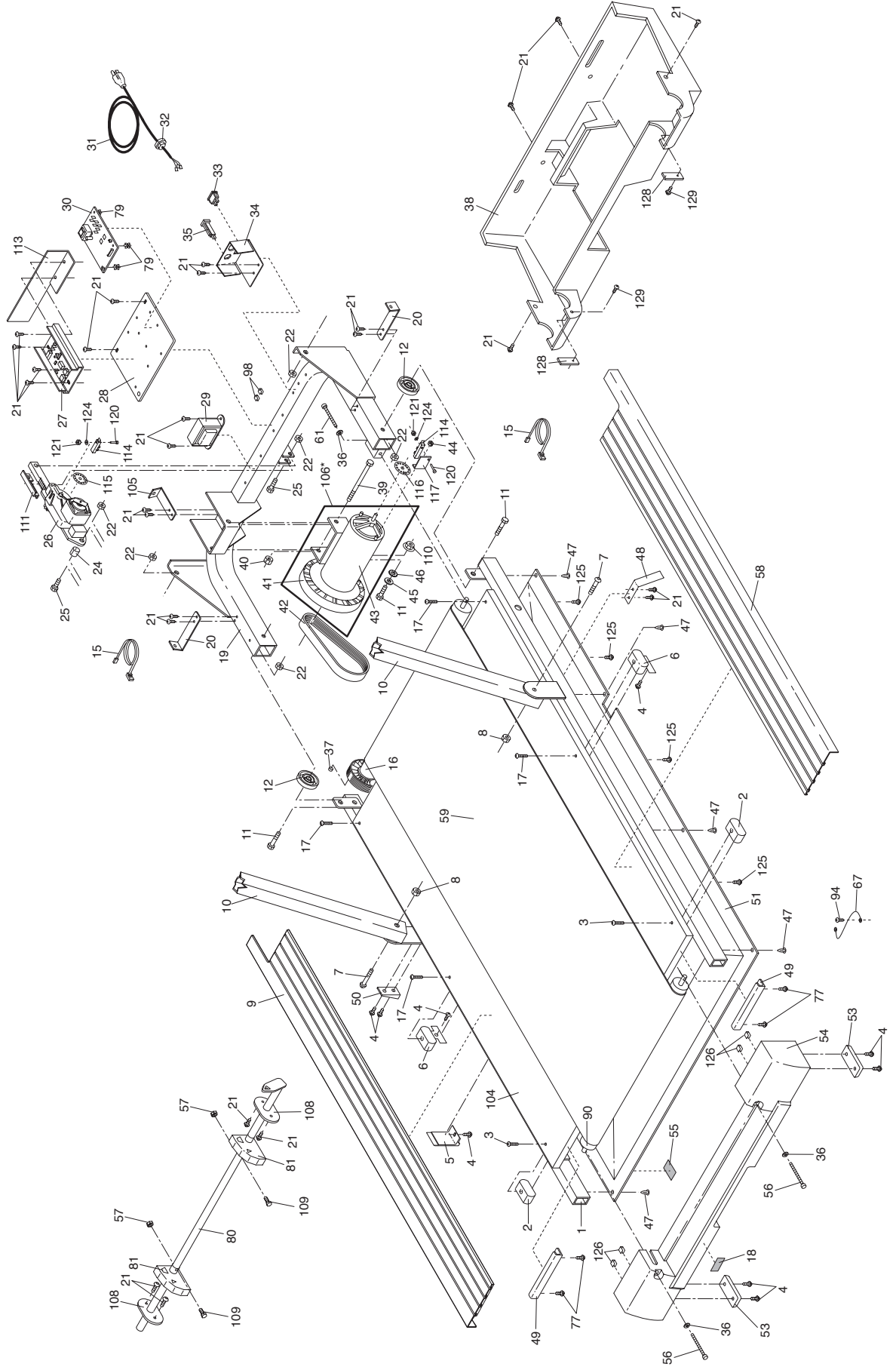

EXPLODED DRAWING — Model No. 831.297783

R0398A

