

# EXPLODED DRAWING A

Model No. 29822.1 R0811A

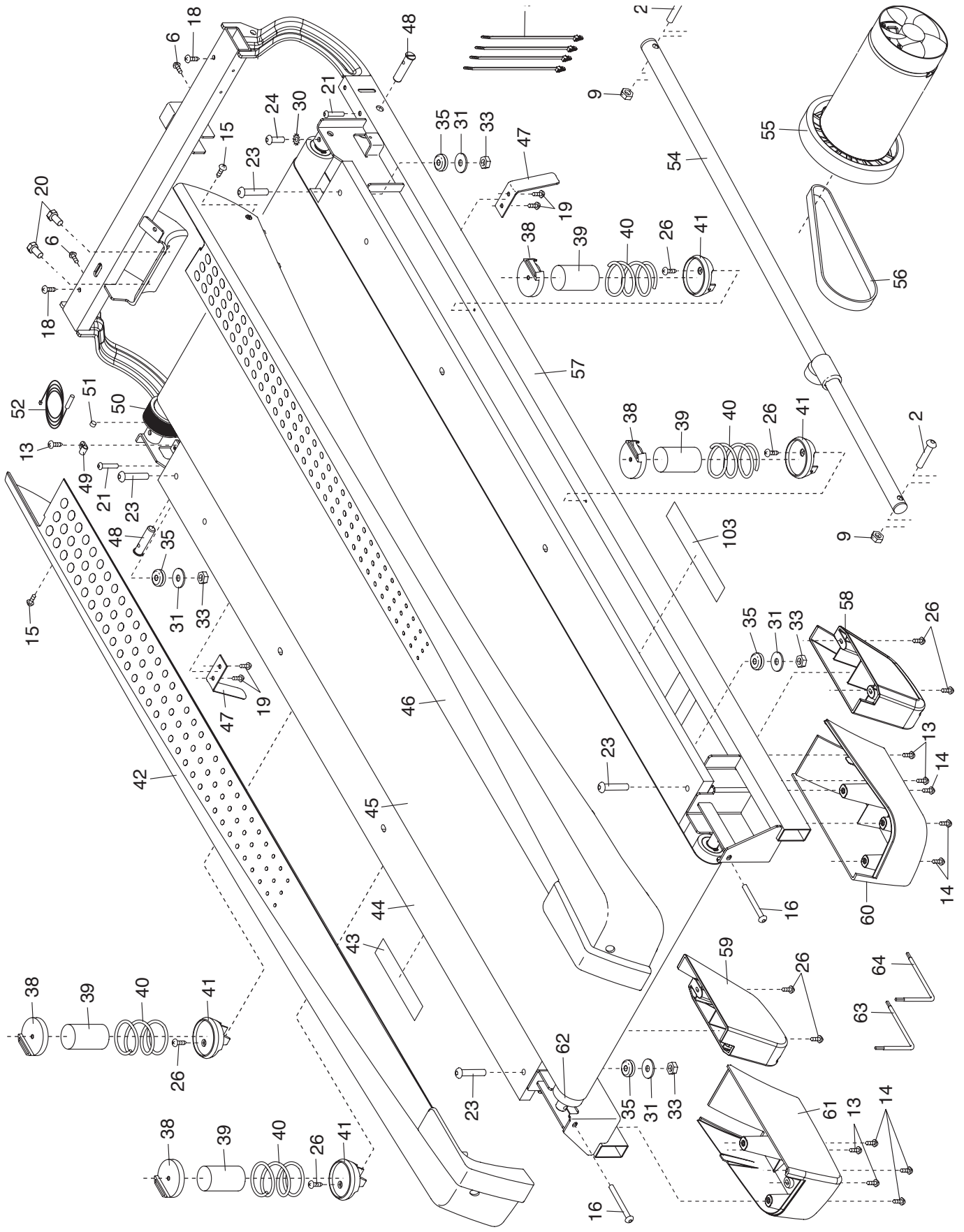

# EXPLODED DRAWING B

Model No. 29822.1 R0811A

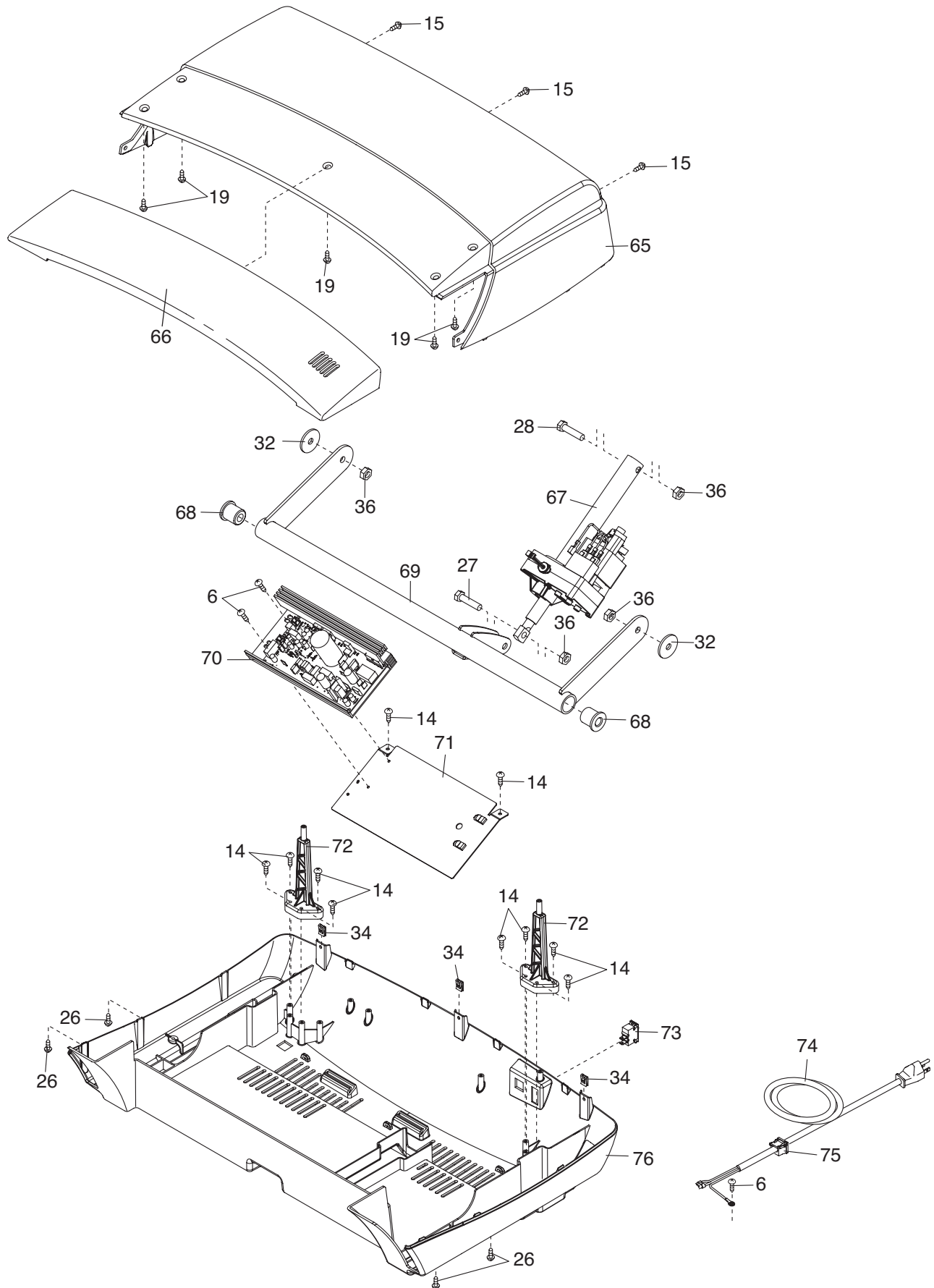

# EXPLODED DRAWING C

Model No. 29822.1 R0811A

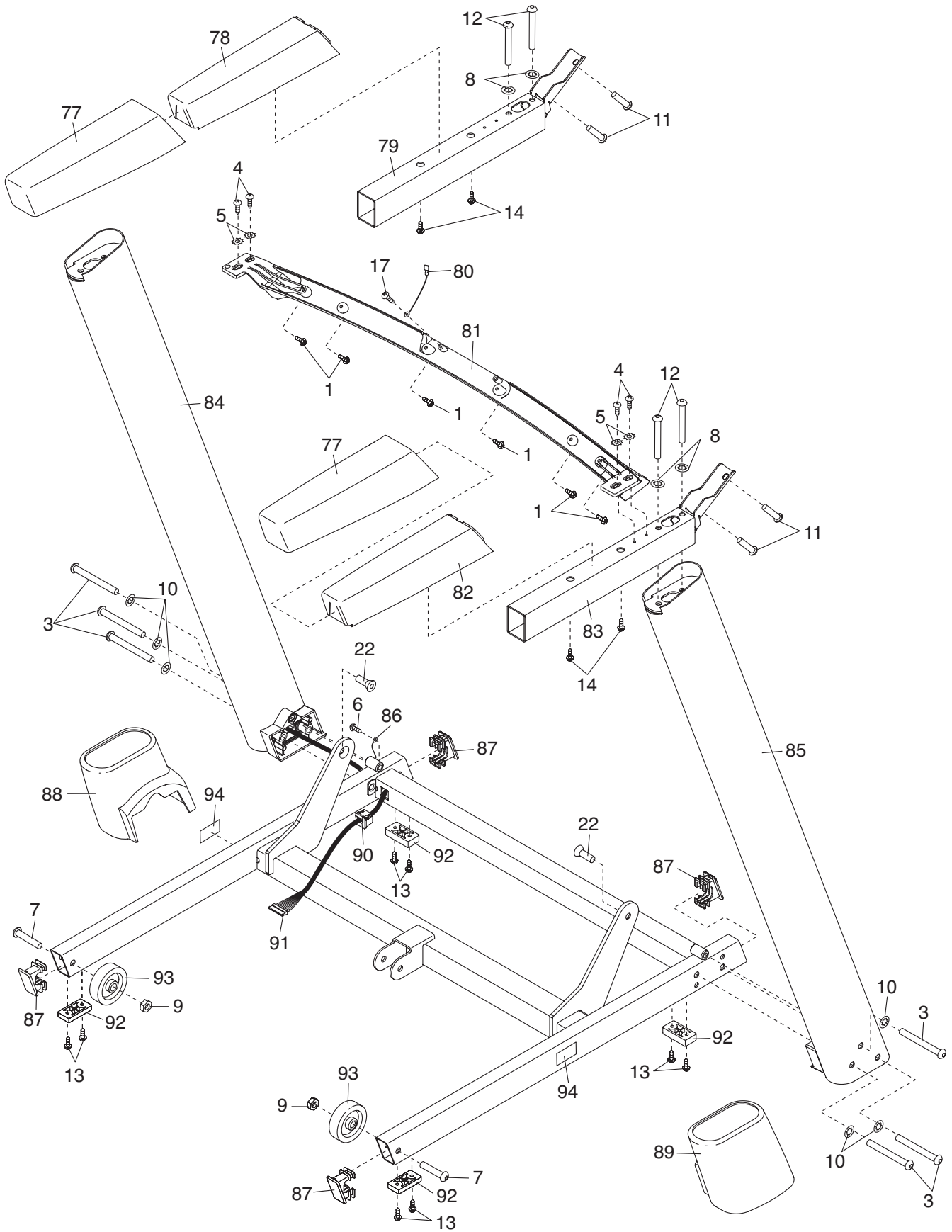

# EXPLODED DRAWING D

Model No. 29822.1 R0811A

