

EXPLODED DRAWING A

Model No. 29822.5 R0313A

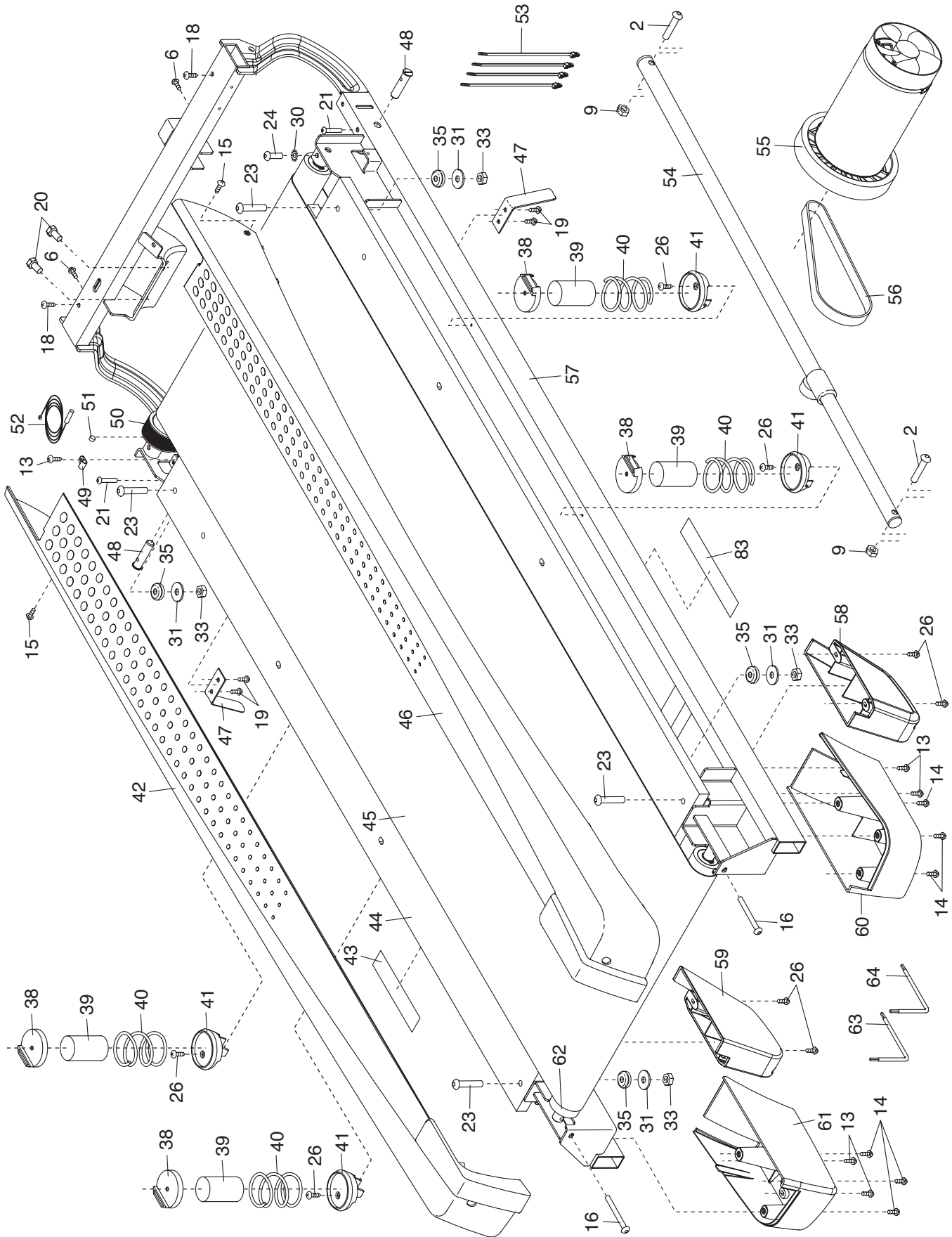

EXPLODED DRAWING B

Model No. 29822.5 R0313A

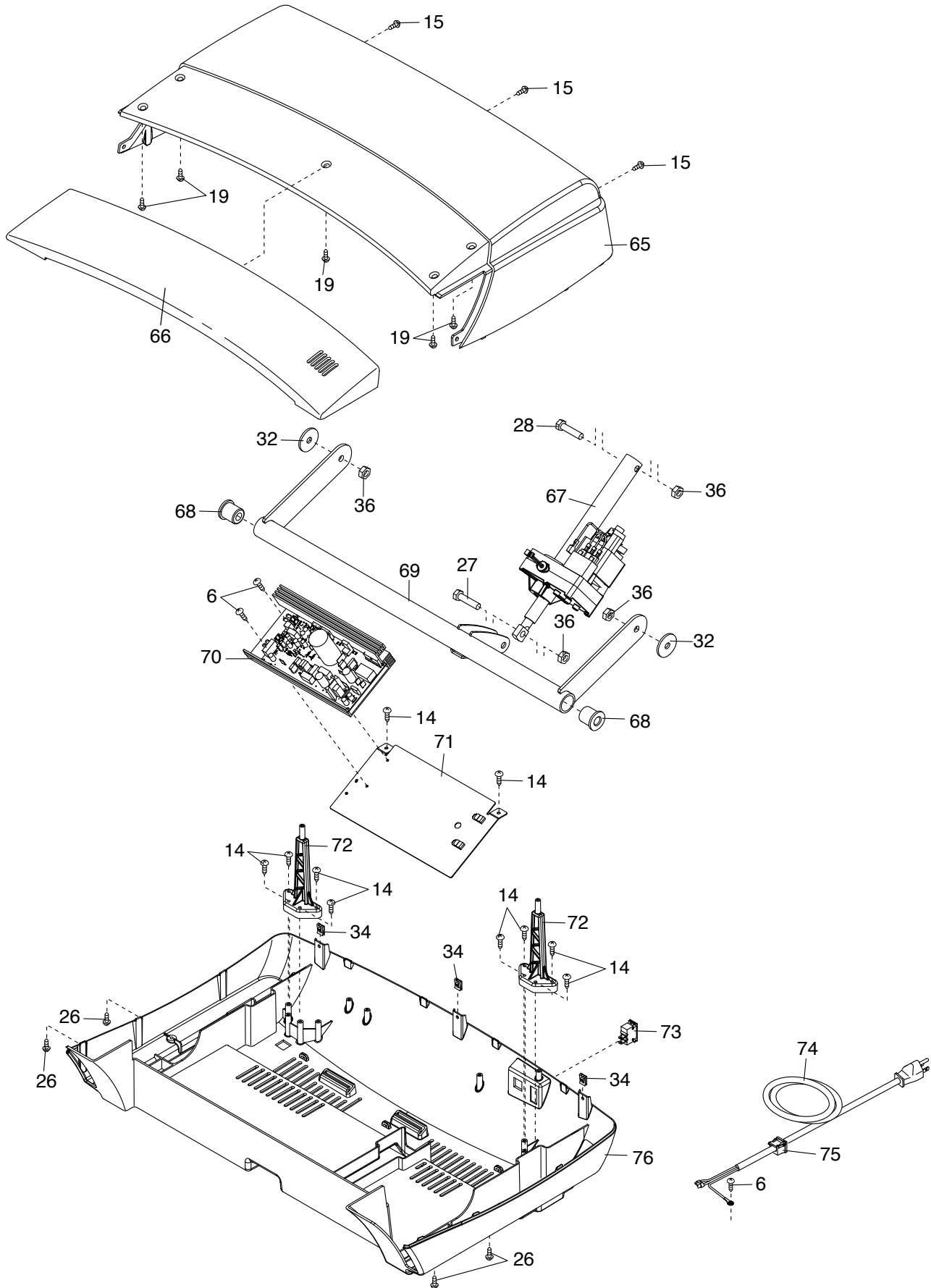

EXPLODED DRAWING C

Model No. 29822.5 R0313A

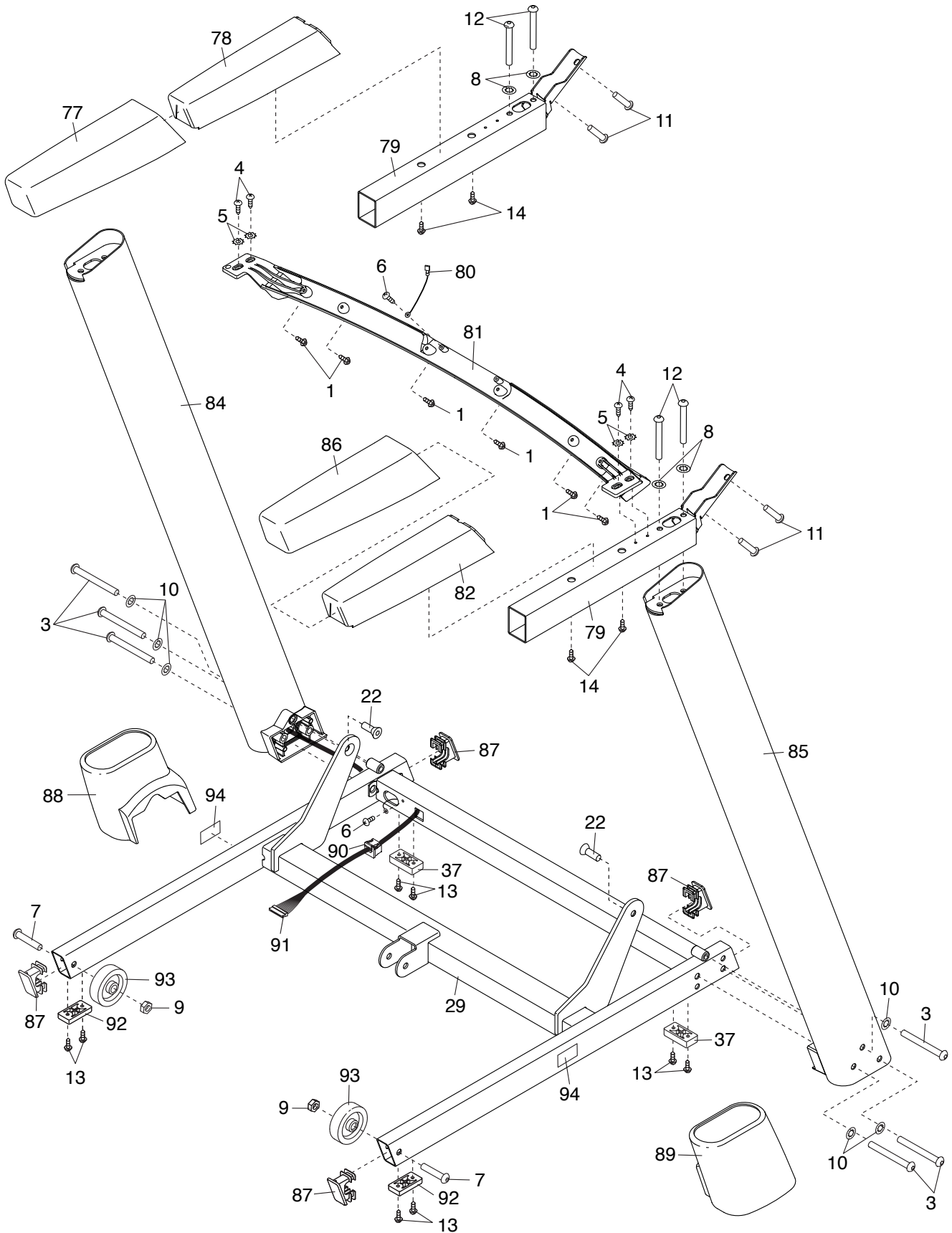

EXPLODED DRAWING D

Model No. 29822.5 R0313A

