

EXPLODED DRAWING A

Model No. 29833.1 R0712A

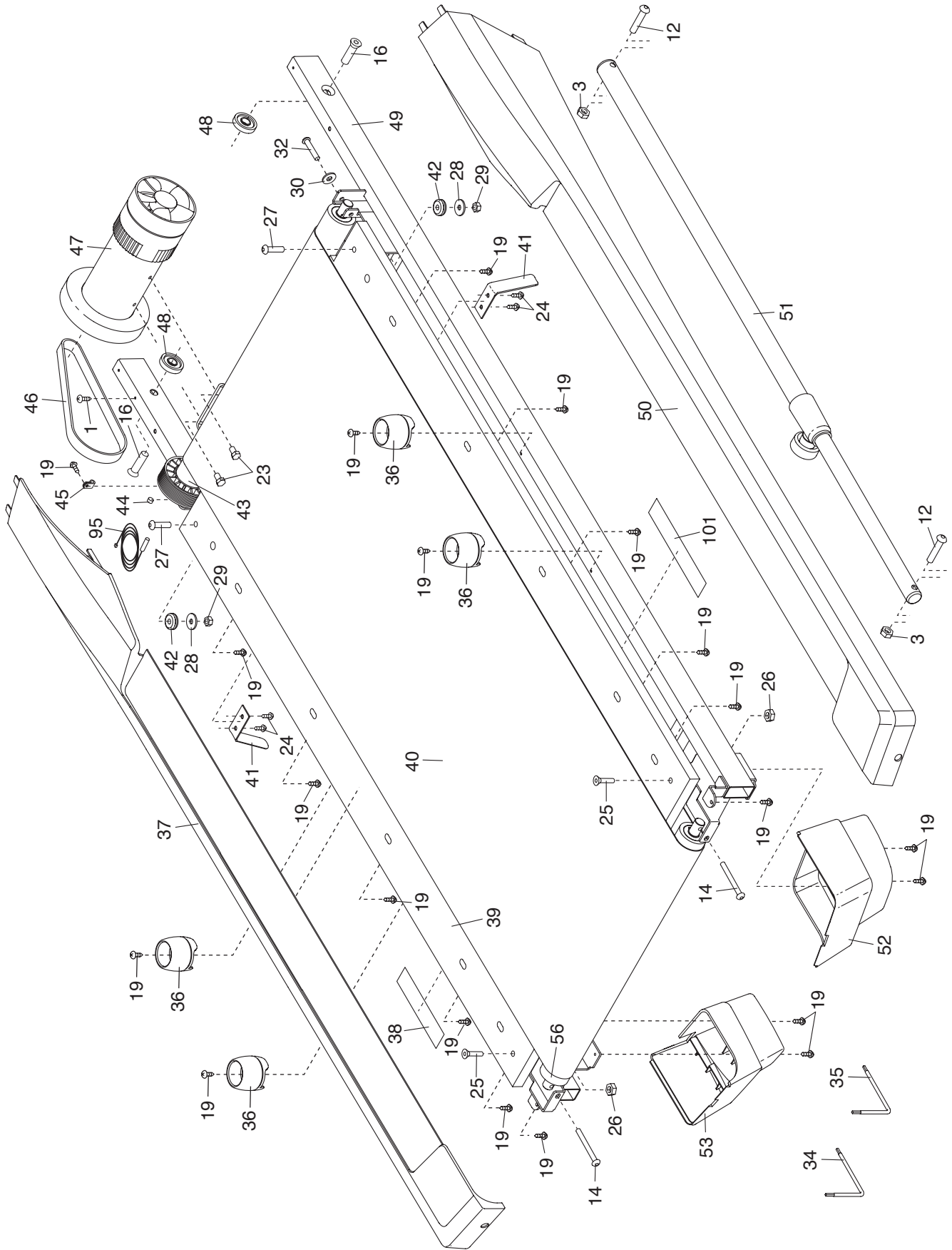

EXPLODED DRAWING B

Model No. 29833.1 R0712A

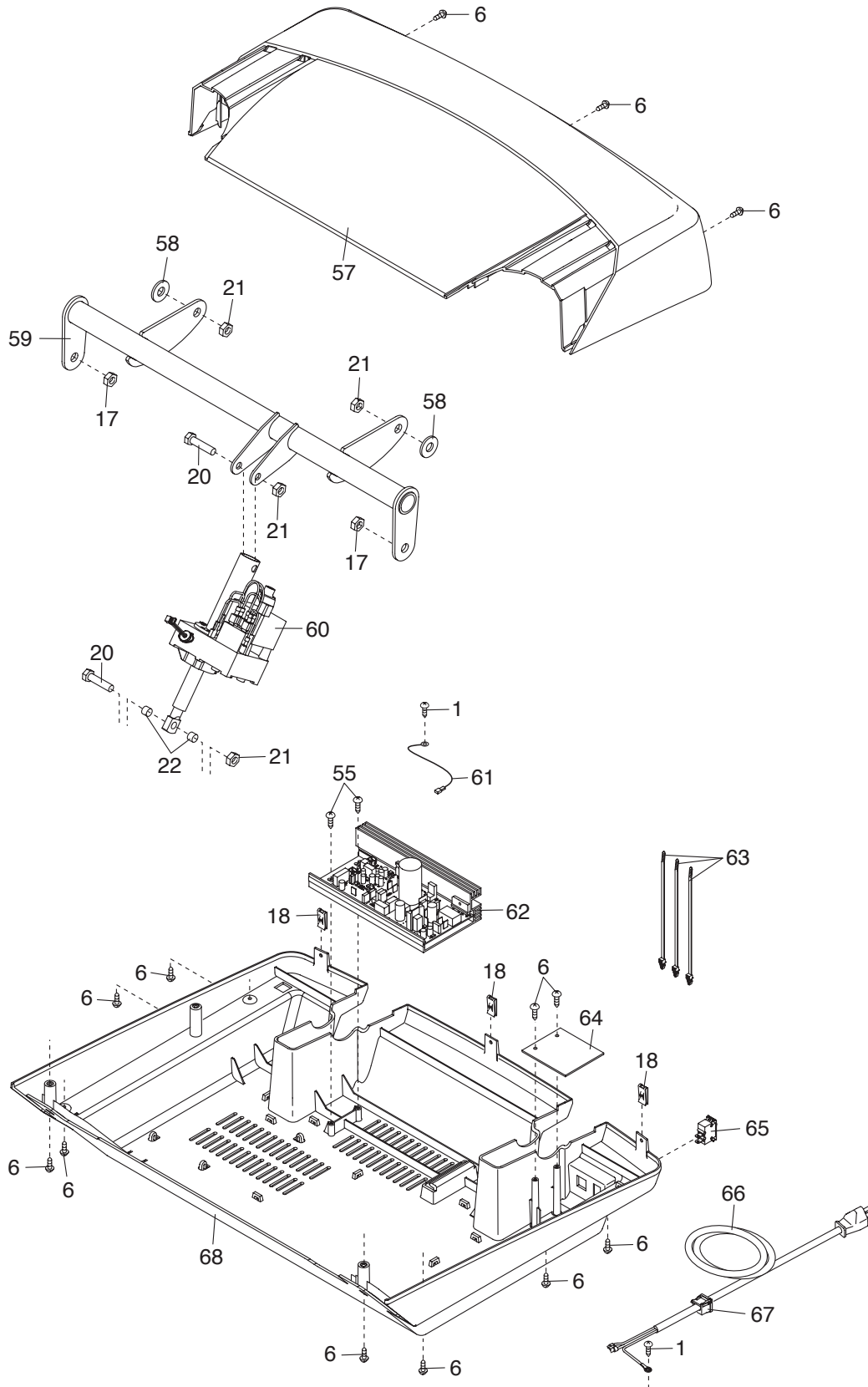

EXPLODED DRAWING C

Model No. 29833.1 R0712A

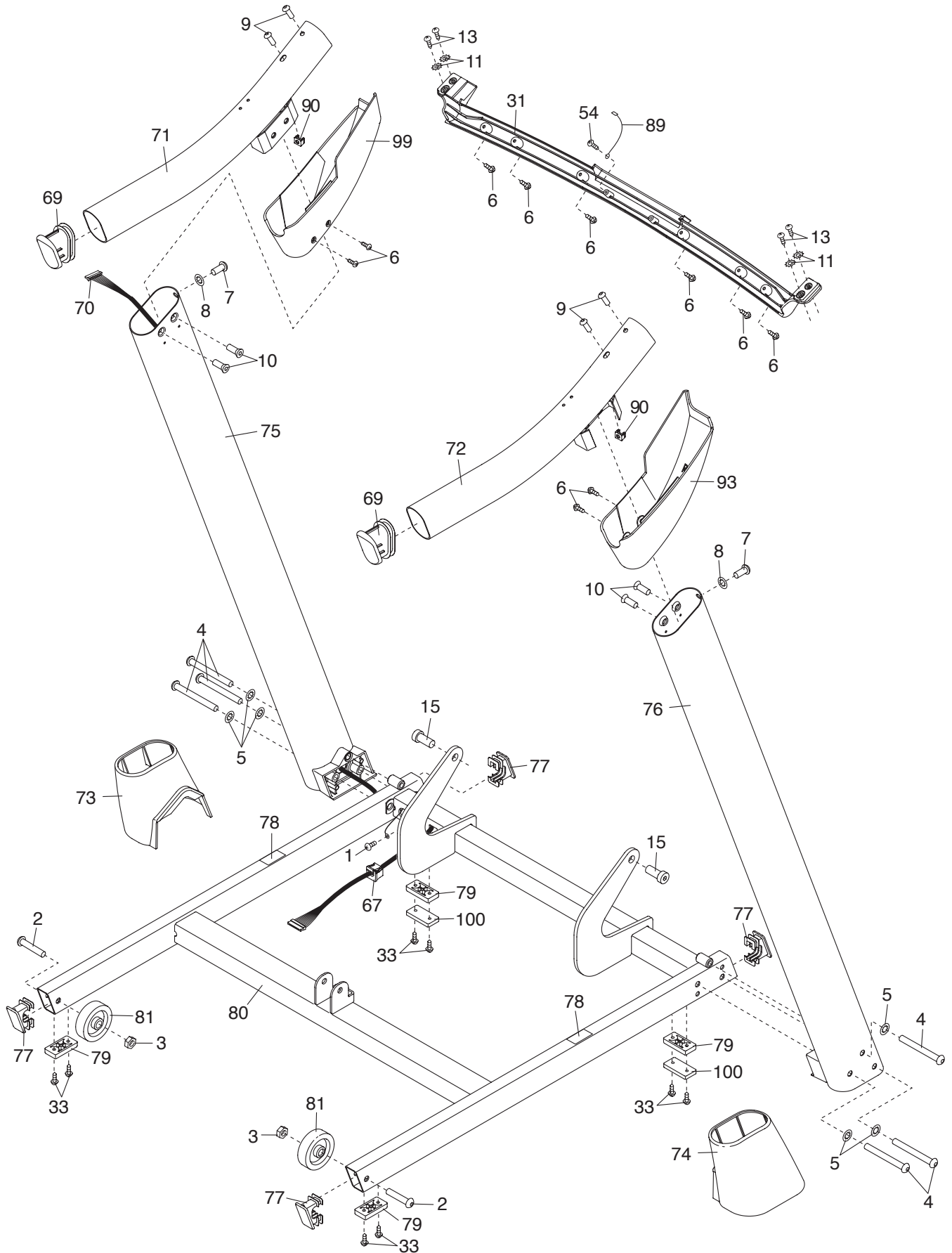

EXPLODED DRAWING D

Model No. 29833.1 R0712A

