

EXPLODED DRAWING A

Model No. 29843.0 R1112A

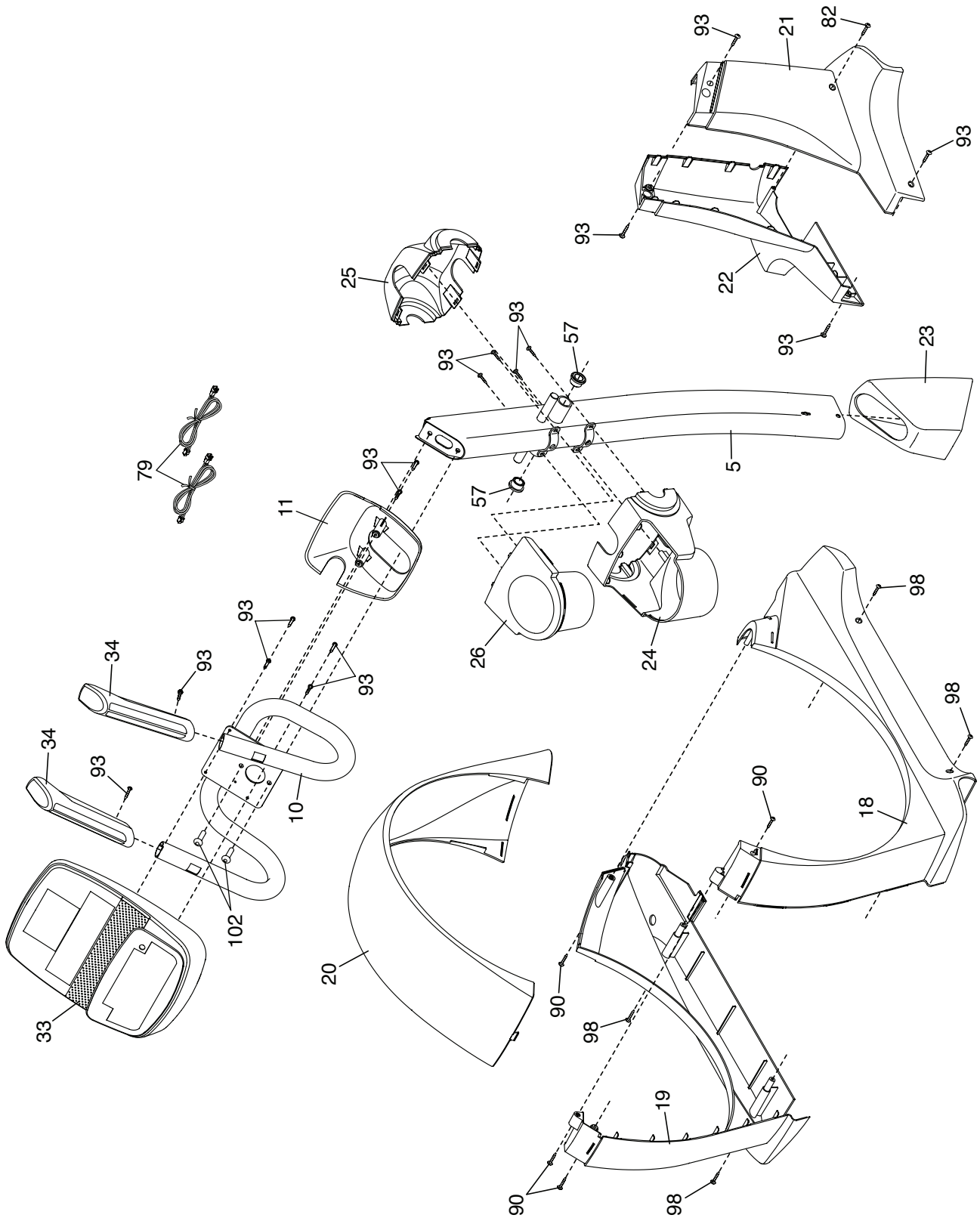

EXPLODED DRAWING B

Model No. 29843.0 R1112A

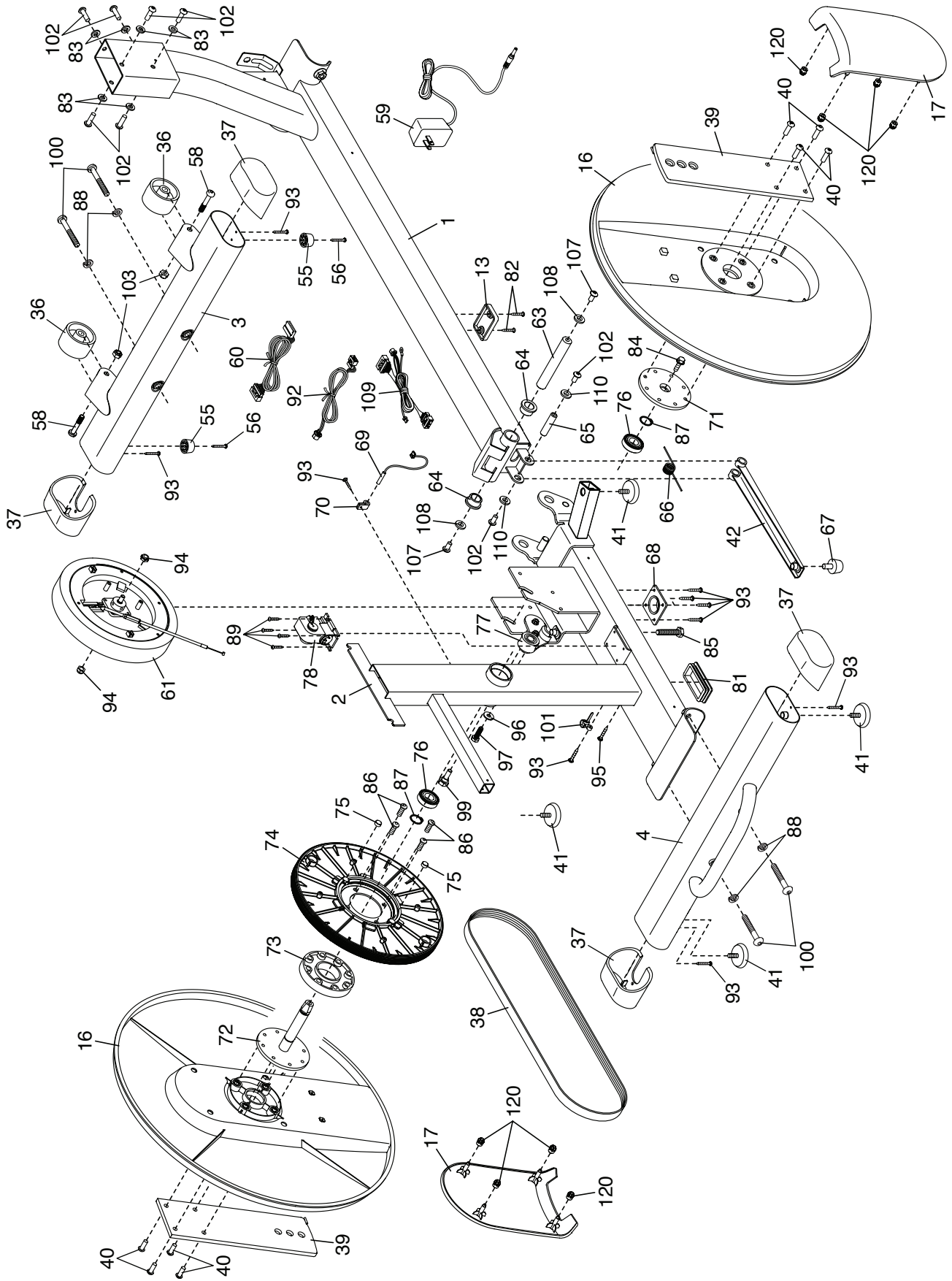

EXPLODED DRAWING C

Model No. 29843.0 R1112A

