

EXPLODED DRAWING A

Model No. 29844.1 R0613A

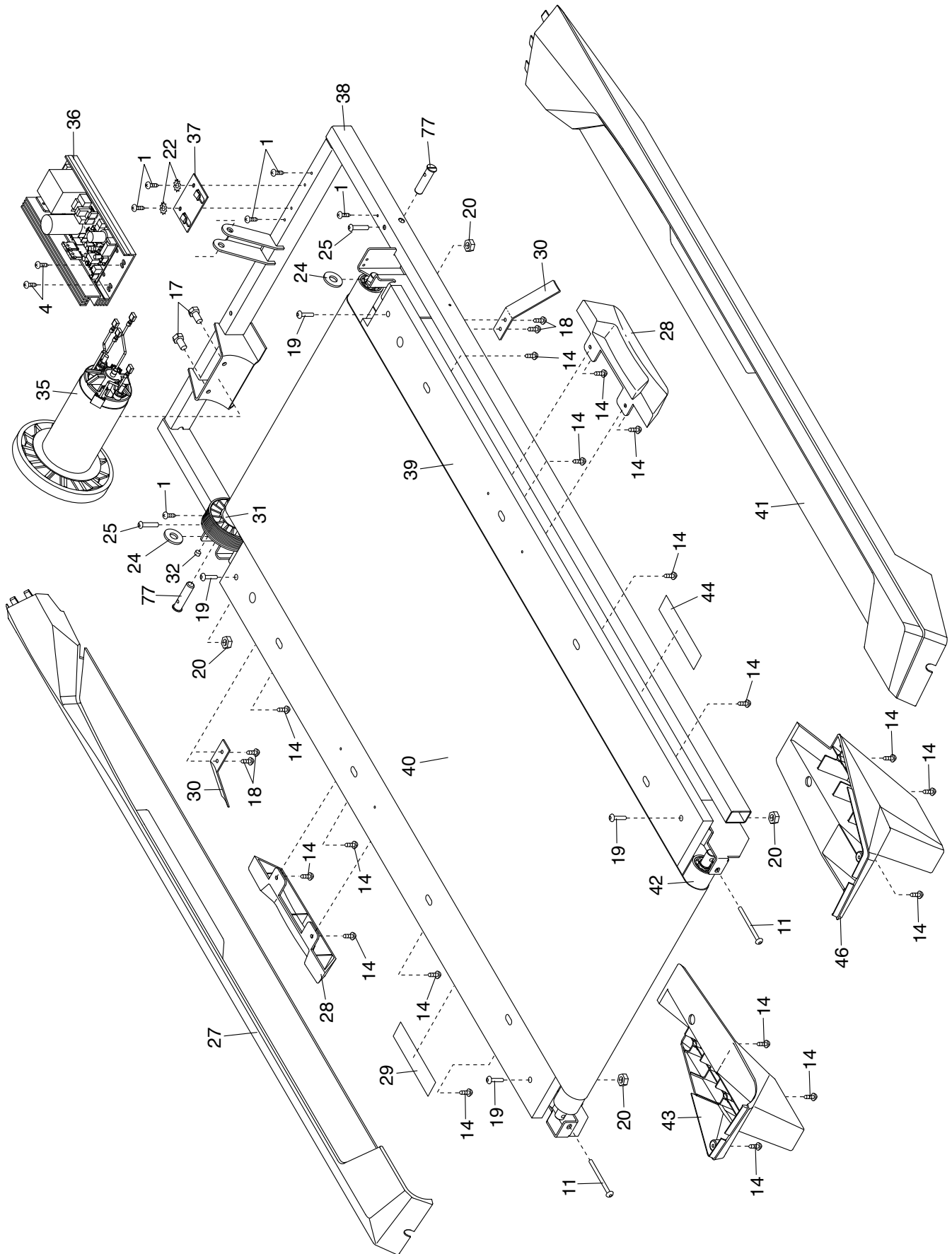

EXPLODED DRAWING B

Model No. 29844.1 R0613A

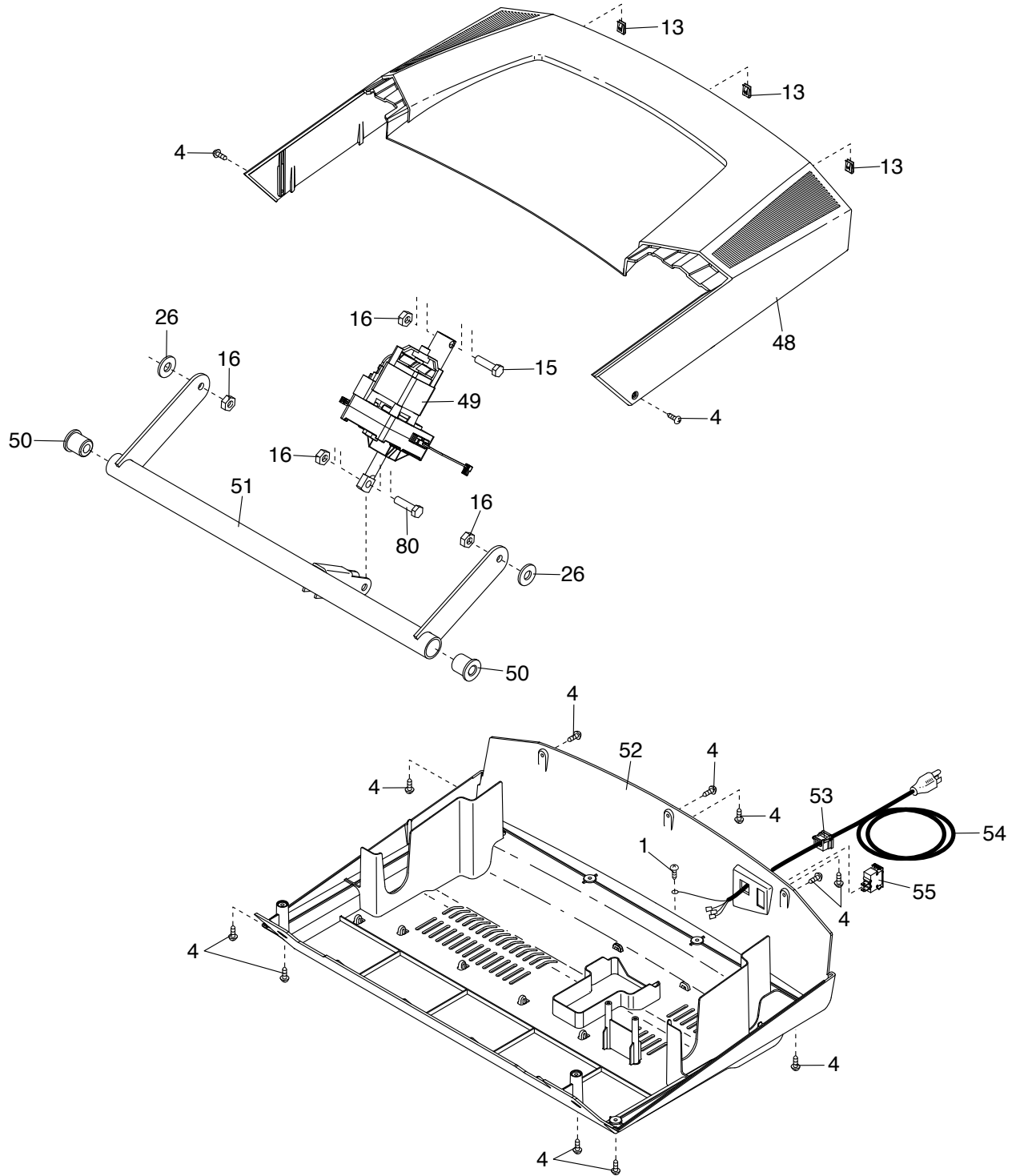

EXPLODED DRAWING C

Model No. 29844.1 R0613A

