

EXPLODED DRAWING A

Model No. 29854.1 R0713A

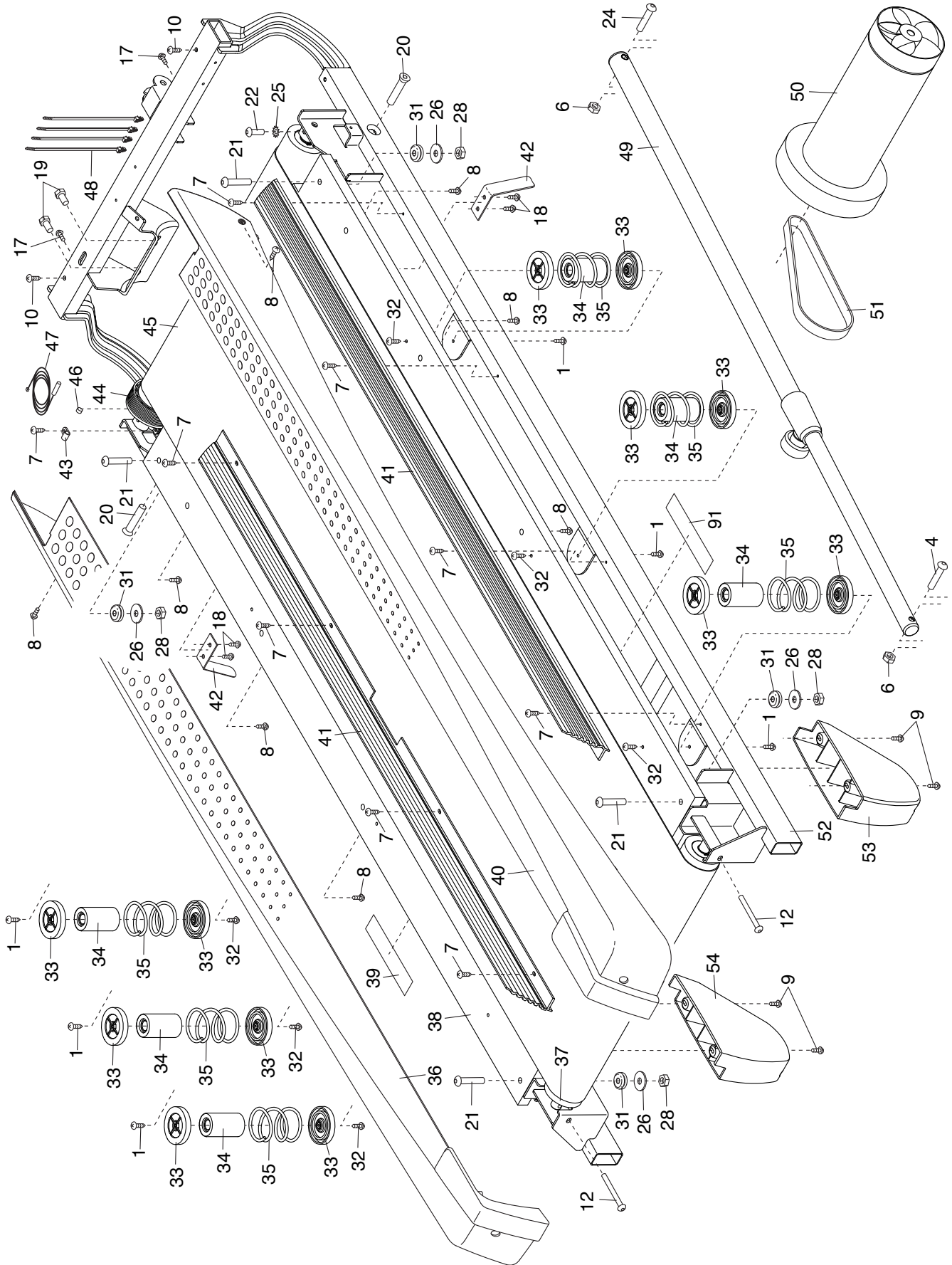

EXPLODED DRAWING B

Model No. 29854.1 R0713A

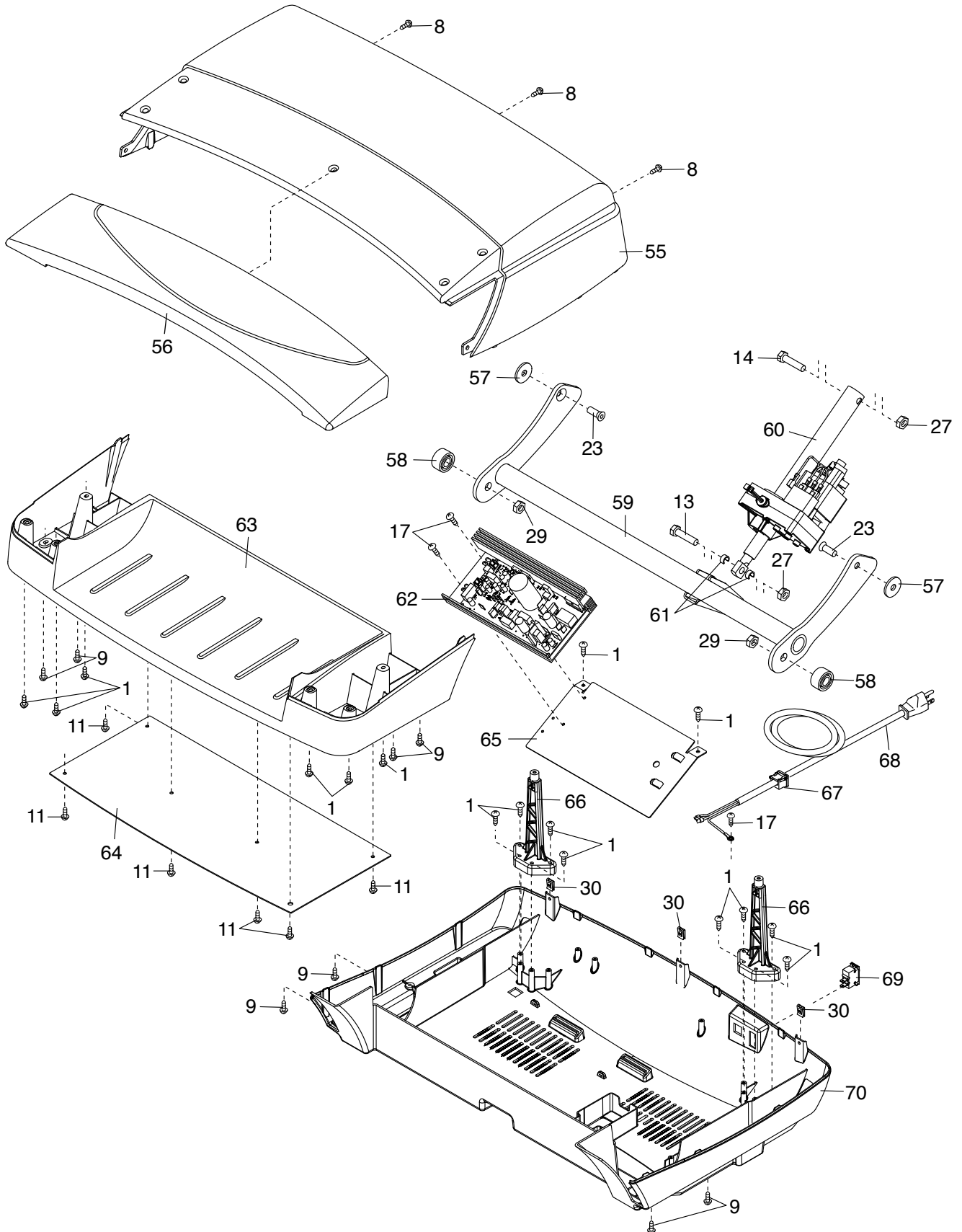

EXPLODED DRAWING C

Model No. 29854.1 R0713A

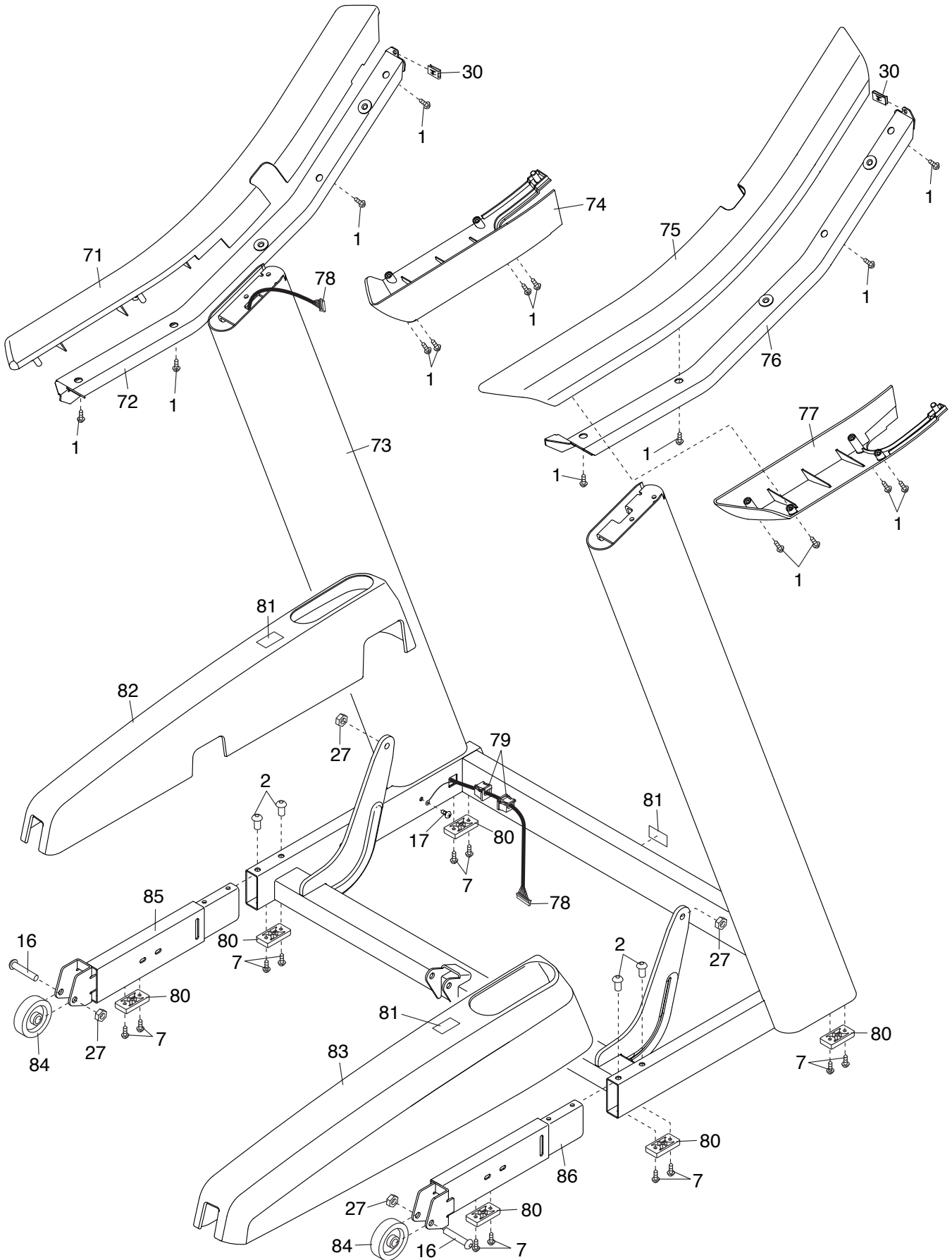

EXPLODED DRAWING D

Model No. 29854.1 R0713A

