

EXPLODED DRAWING A

Model No. 29860.0 R1212A

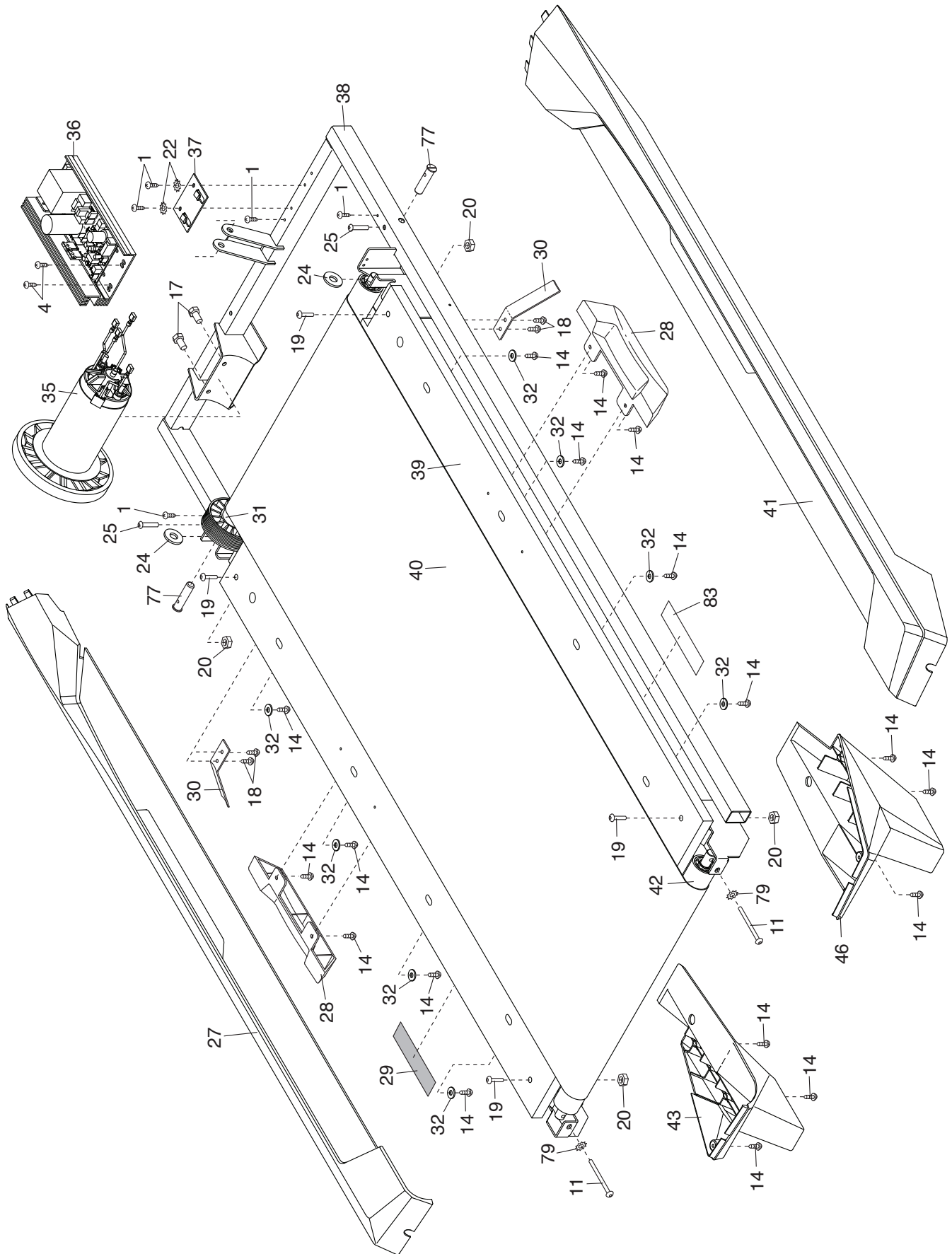

EXPLODED DRAWING B

Model No. 29860.0 R1212A

