

EXPLODED DRAWING A

Model No. 29860.1 R0813A

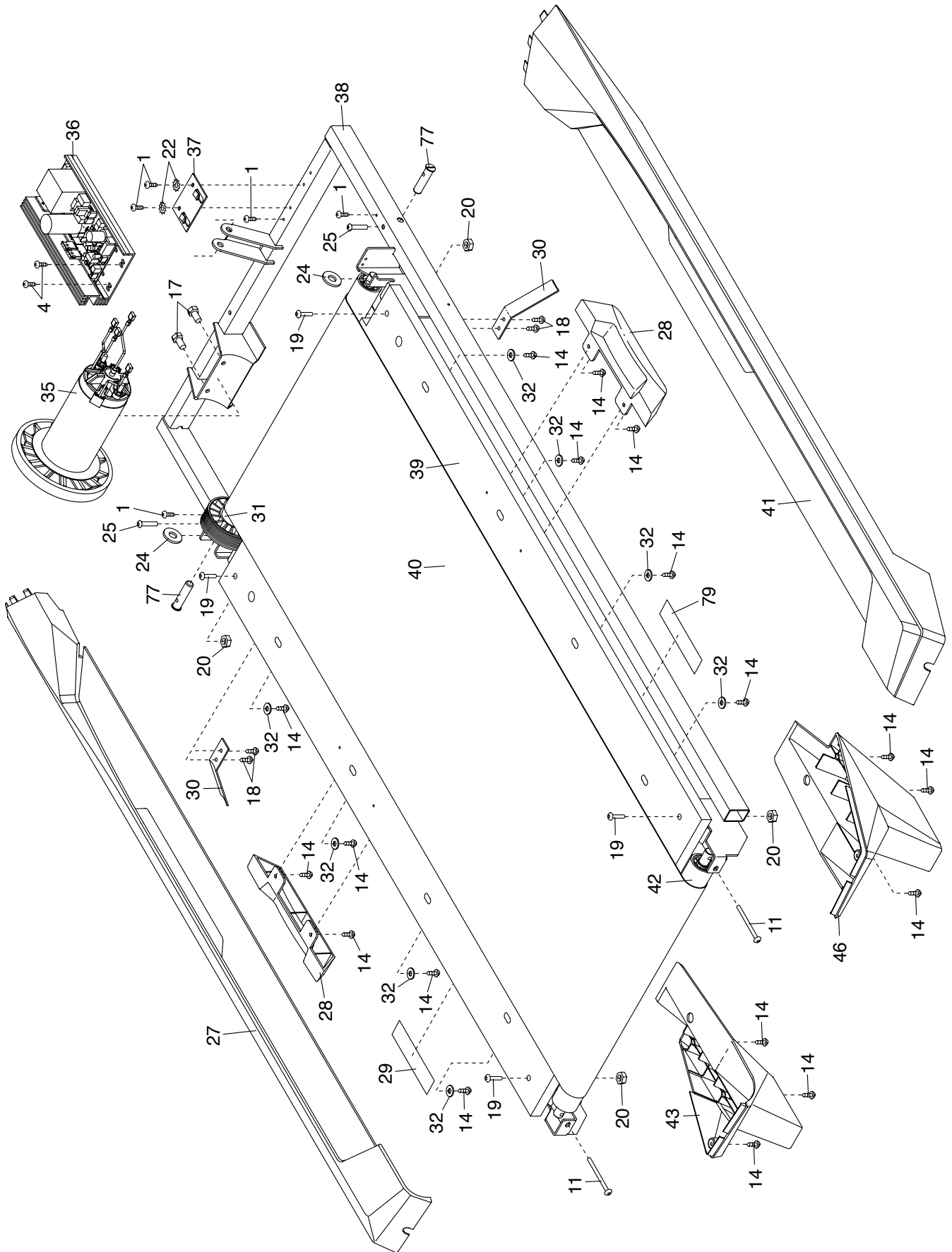

EXPLODED DRAWING B

Model No. 29860.1 R0813A

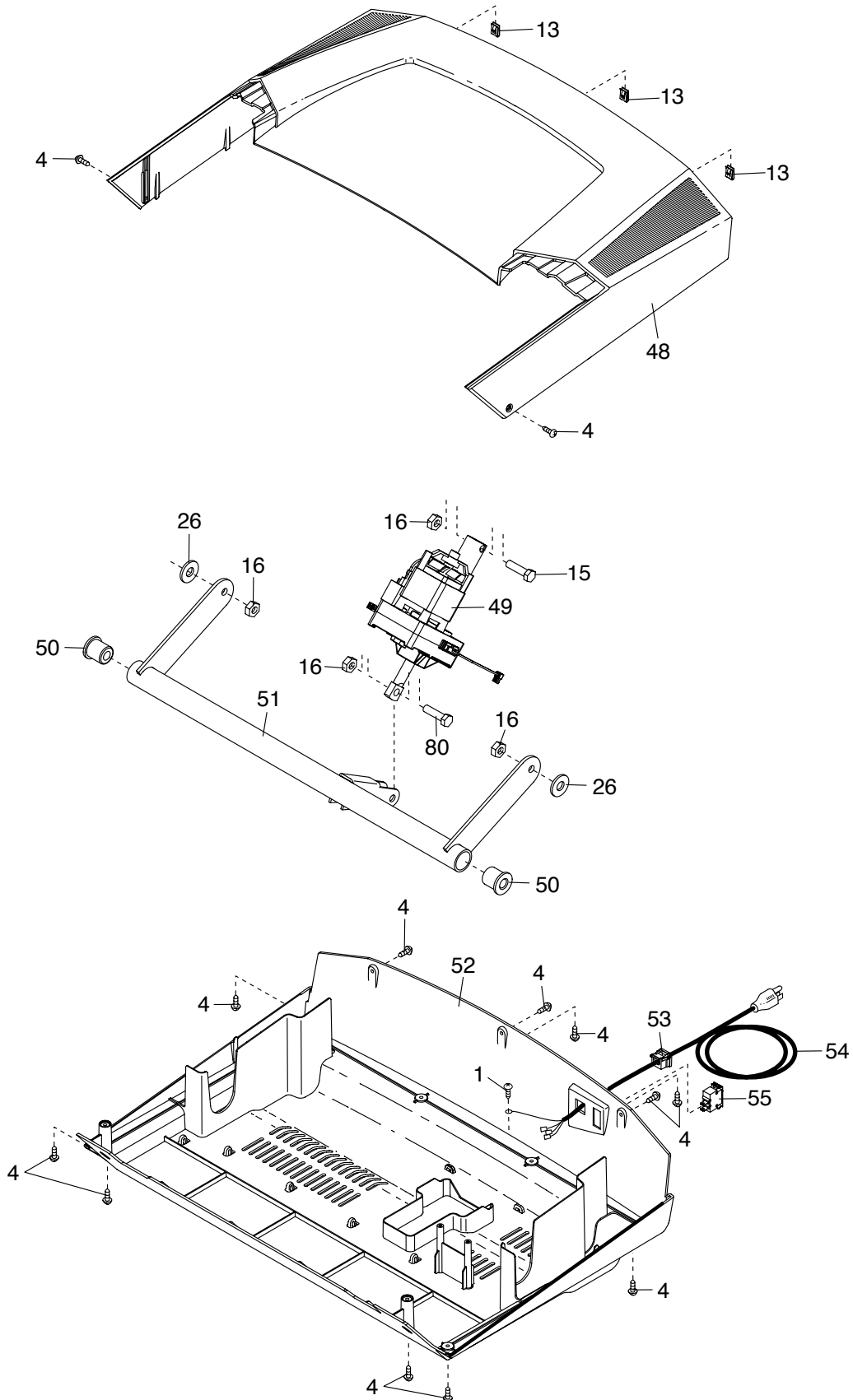

EXPLODED DRAWING C

Model No. 29860.1 R0813A

