

# EXPLODED DRAWING—Model No. 831.299351

R0200A

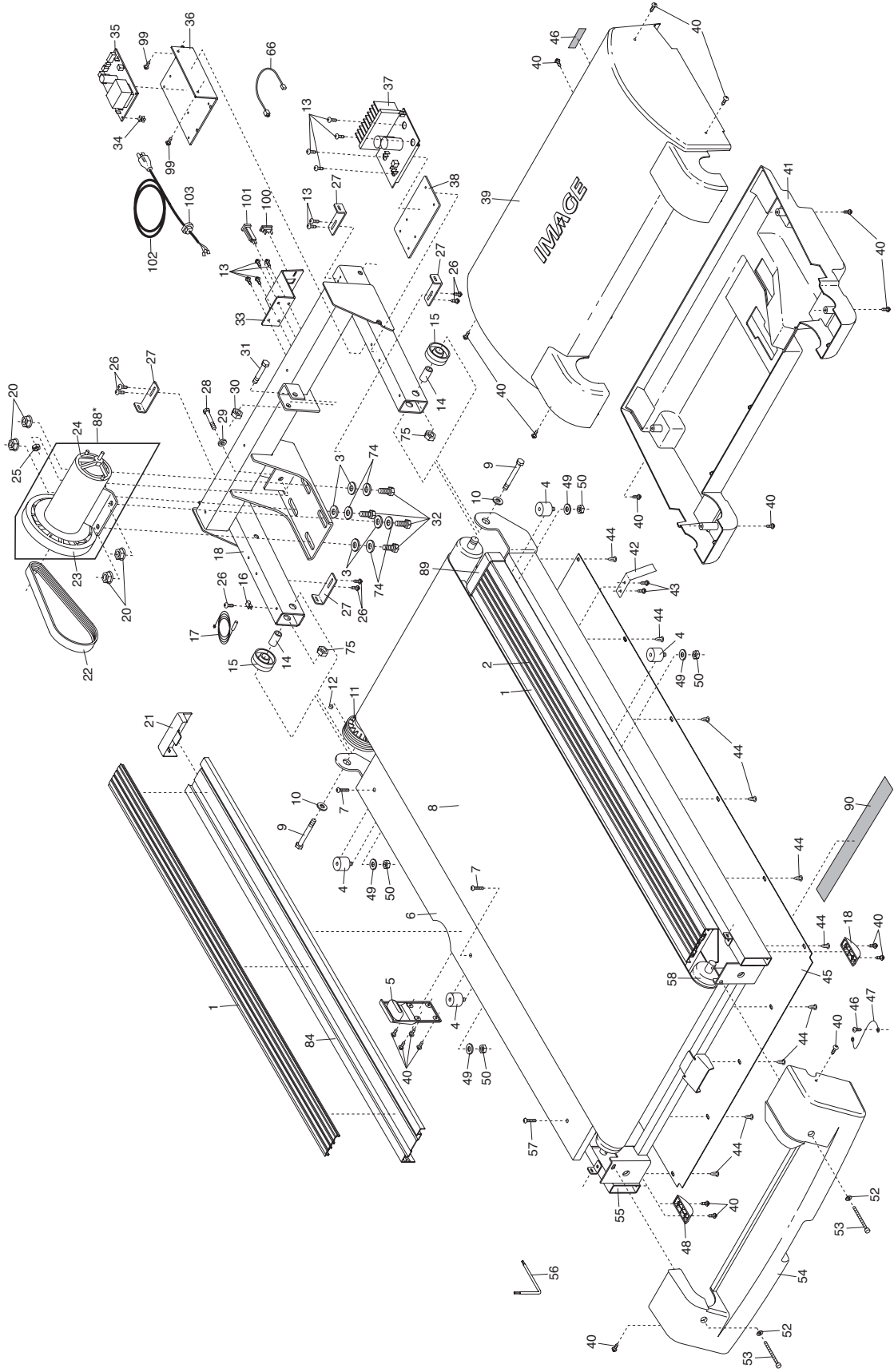

# EXPLODED DRAWING—Model No. 831.299351

R0200A

