

EXPLODED DRAWING A—Model No. 30669.0

R0809A

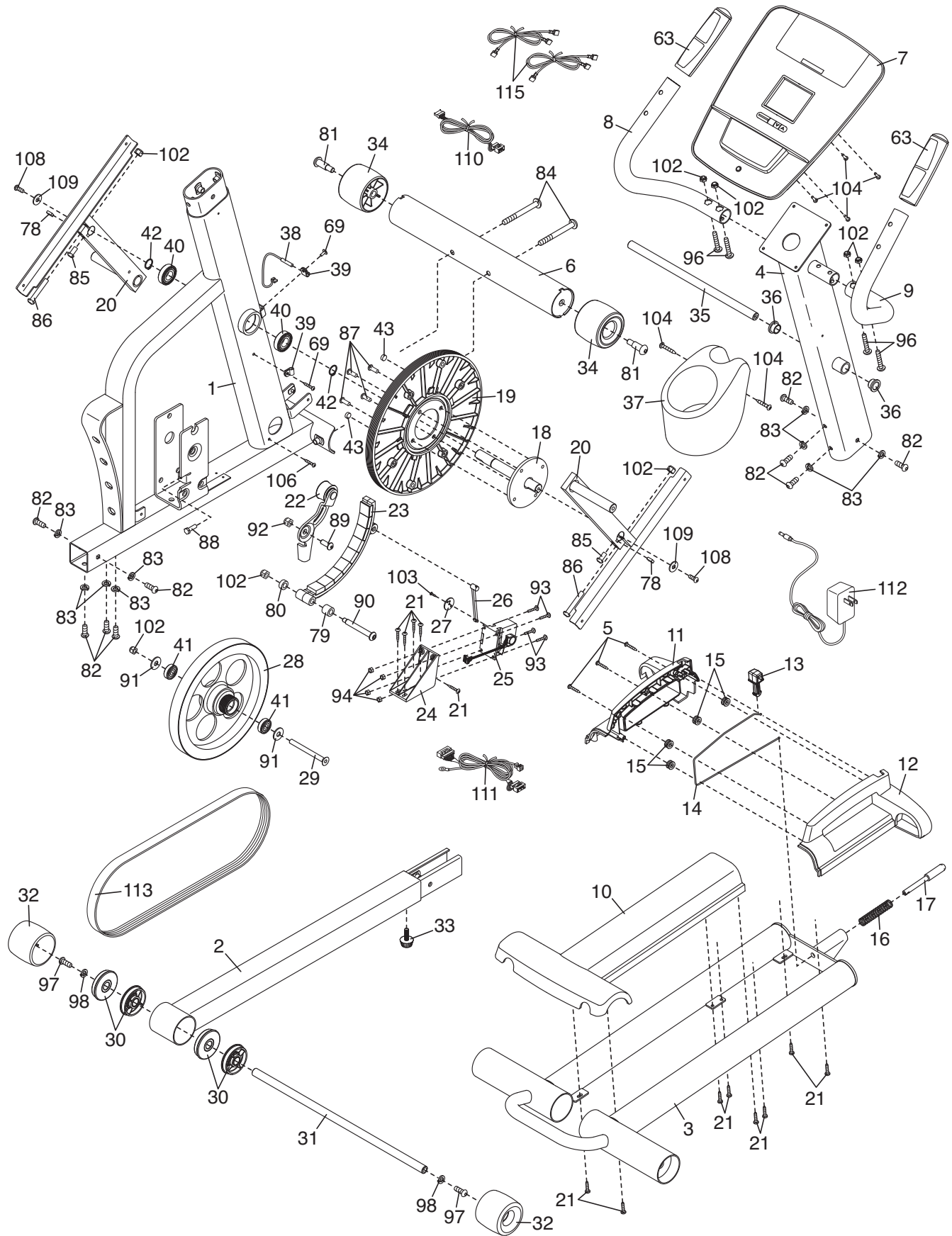

EXPLODED DRAWING B—Model No. 30669.0

R0809A

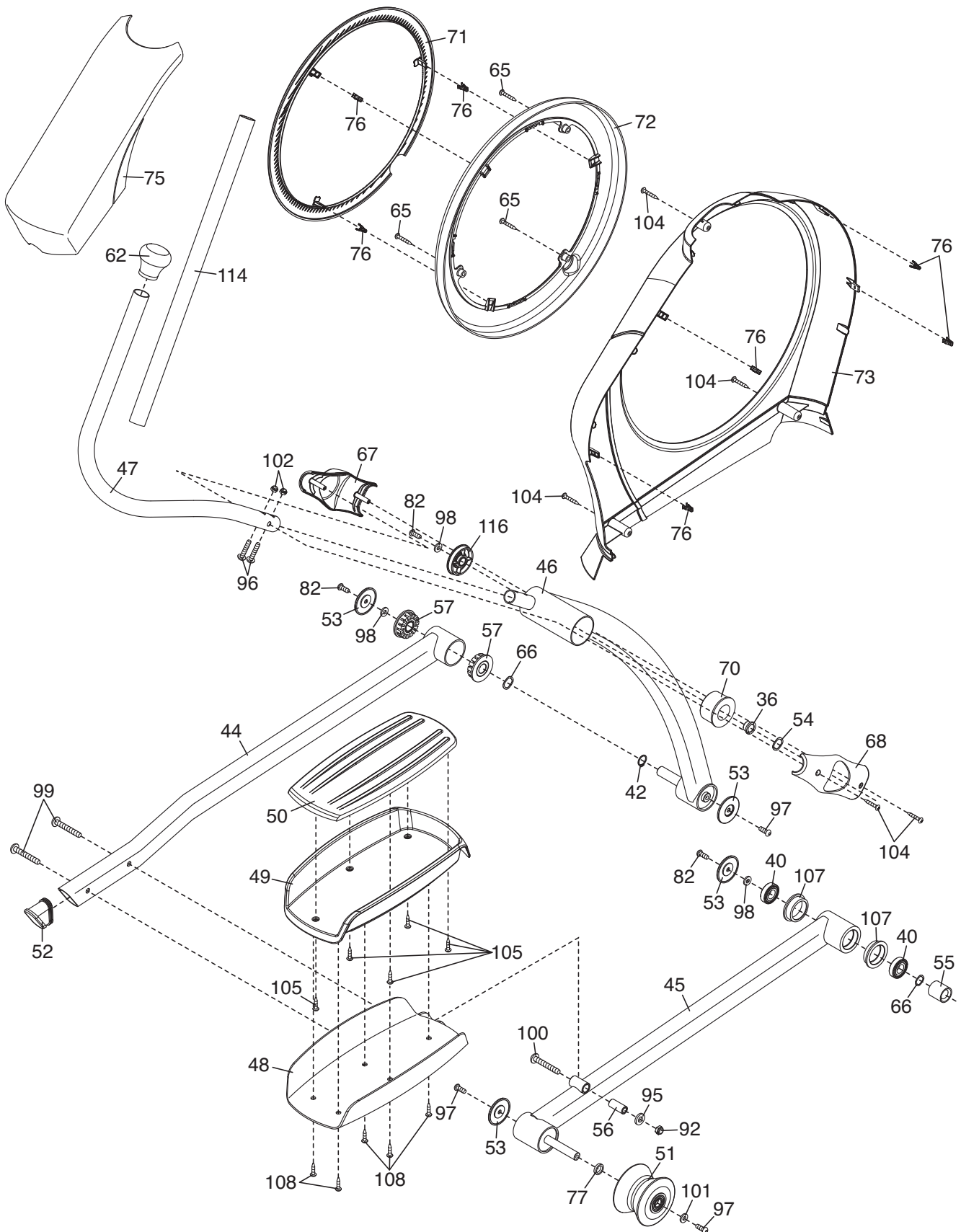

EXPLODED DRAWING C—Model No. 30669.0

R0809A

