

EXPLODED DRAWING A—Model No. 30707.0

R0407A

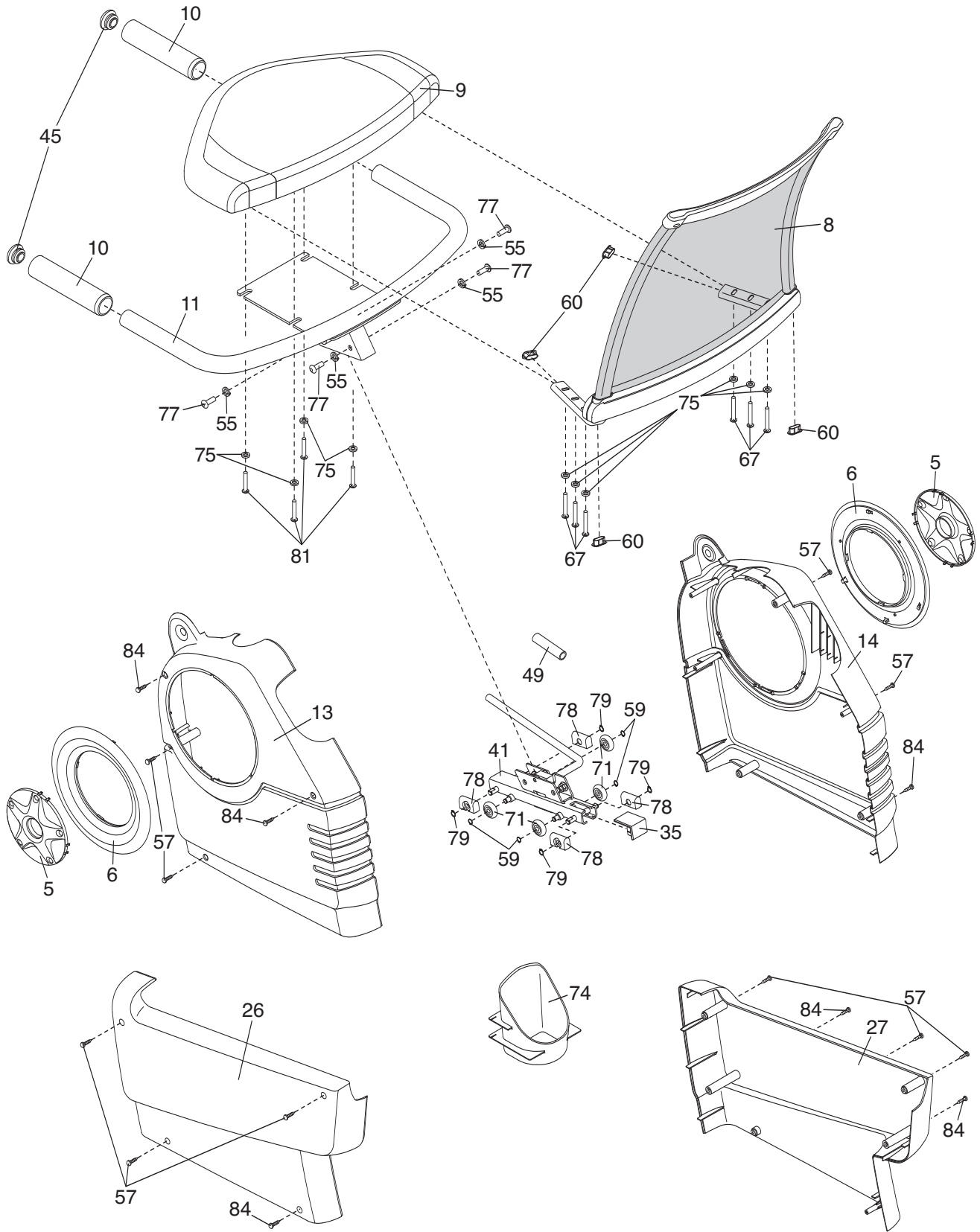

EXPLODED DRAWING B—Model No. 30707.0

R0407A

