

# EXPLODED DRAWING A—Model No. 30707.3

R0608A

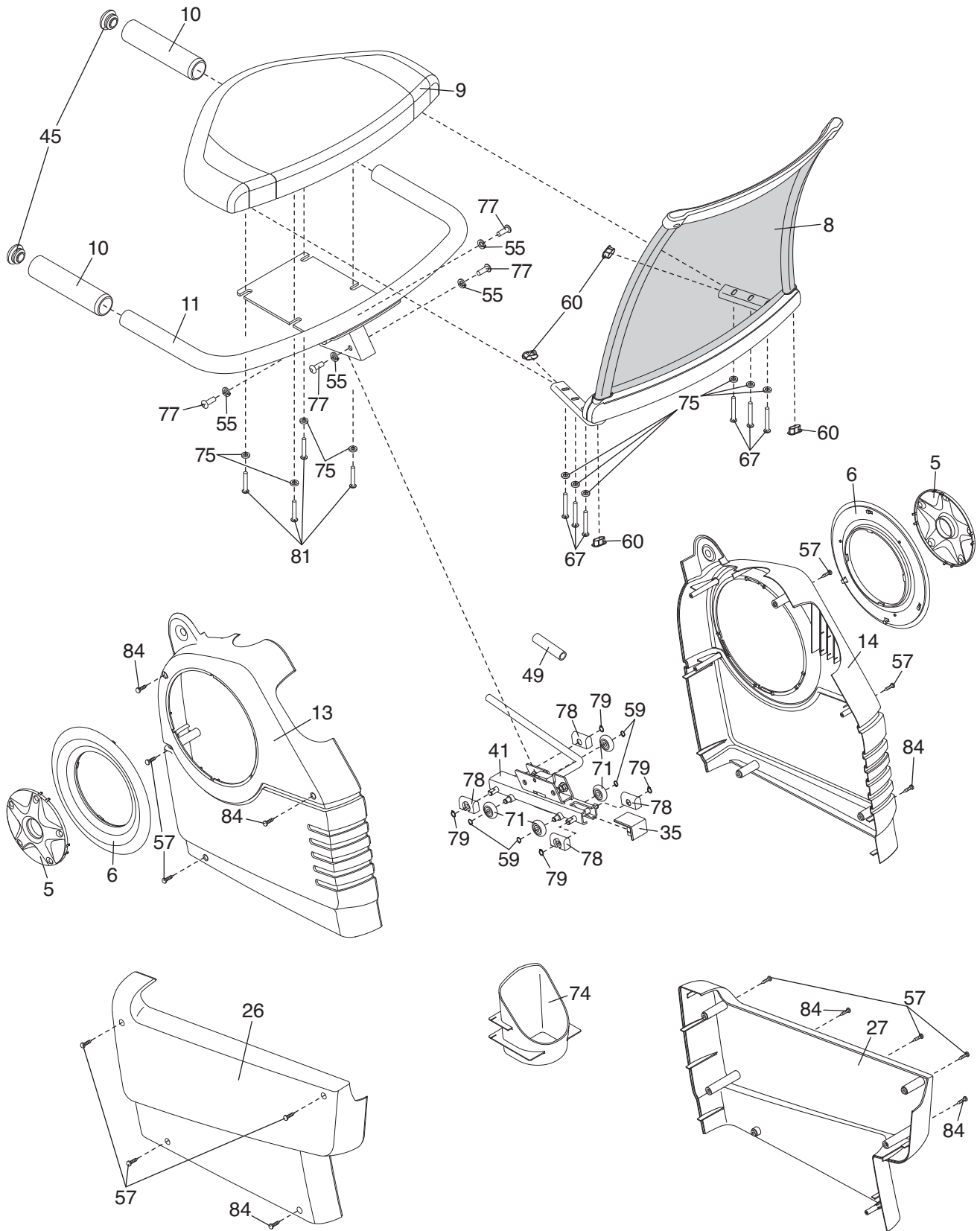

# EXPLODED DRAWING B—Model No. 30707.3

R0608A

