

EXPLODED DRAWING A

Model No. 831.24853.0 R0713B

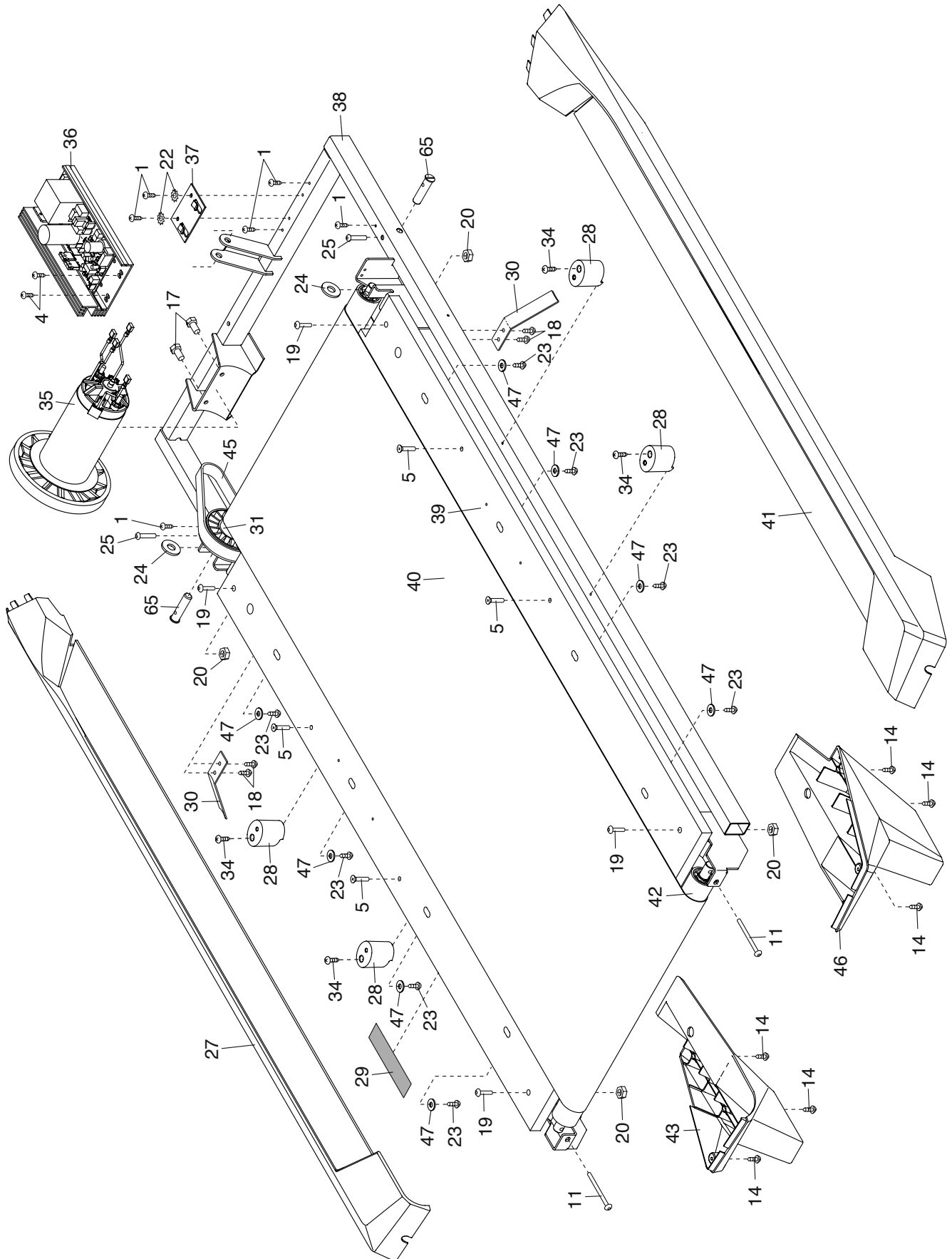

EXPLODED DRAWING B

Model No. 831.24853.0 R0713B

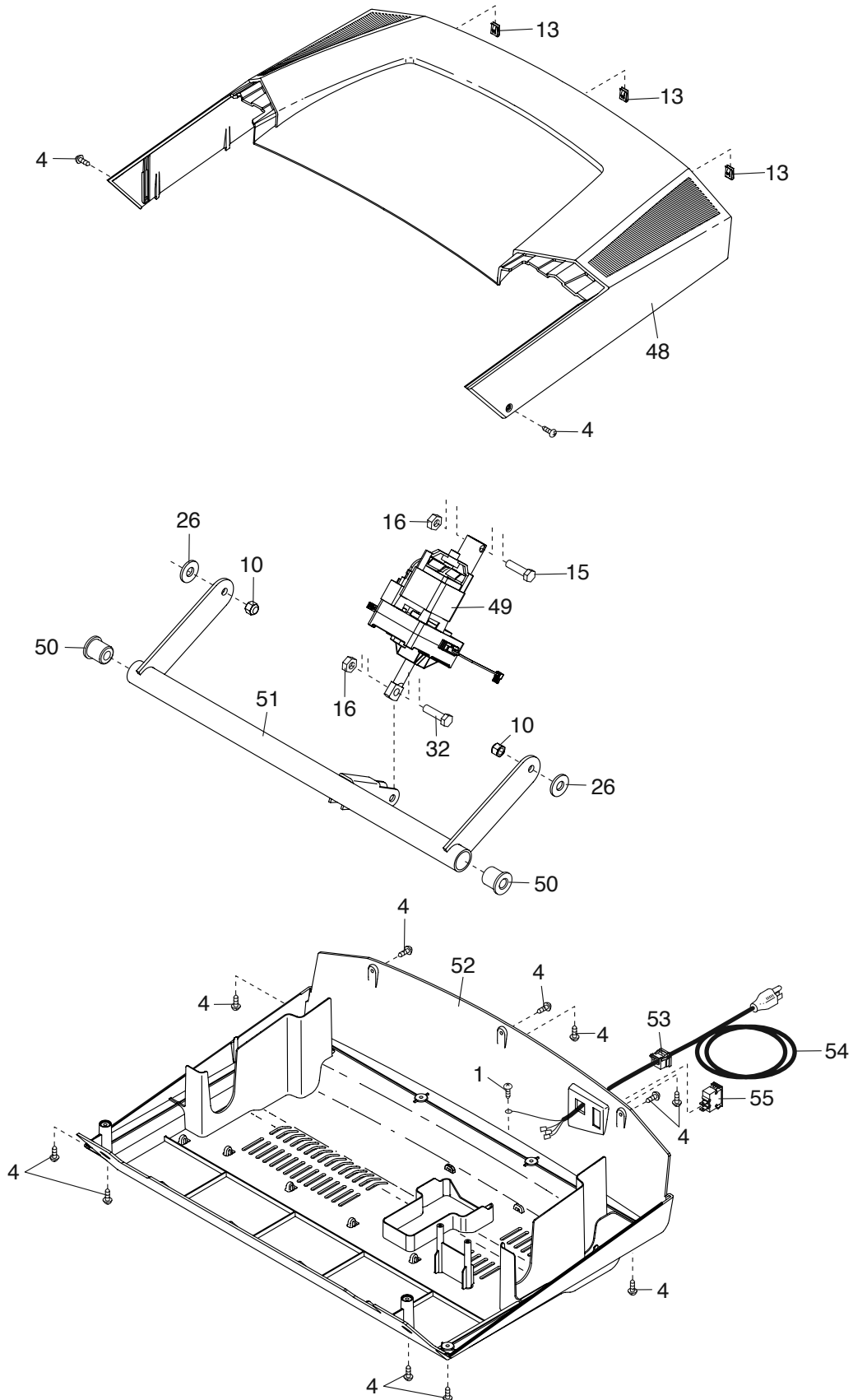

EXPLODED DRAWING C

Model No. 831.24853.0 R0713B

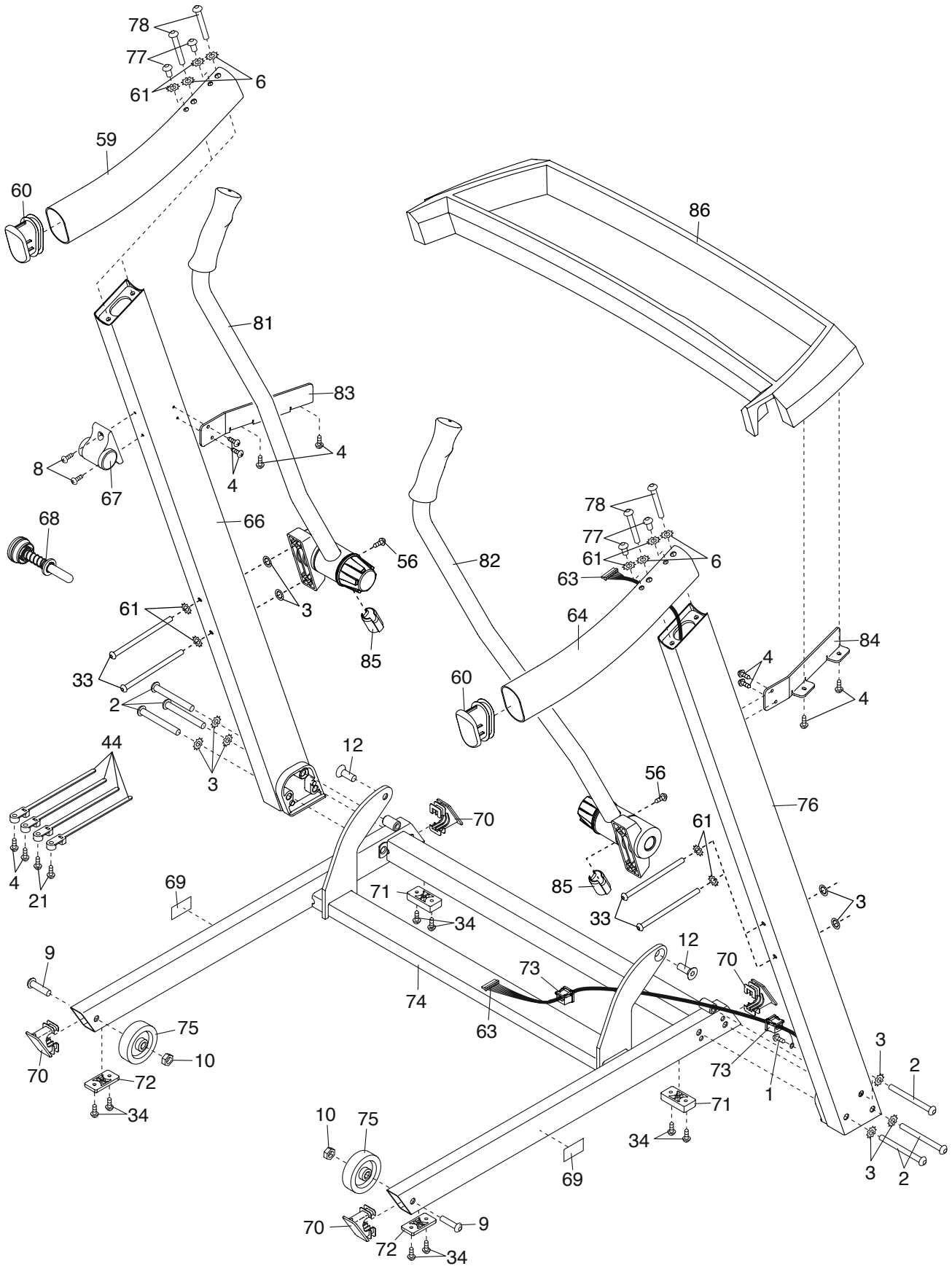

EXPLODED DRAWING D

Model No. 831.24853.0 R0713B

