

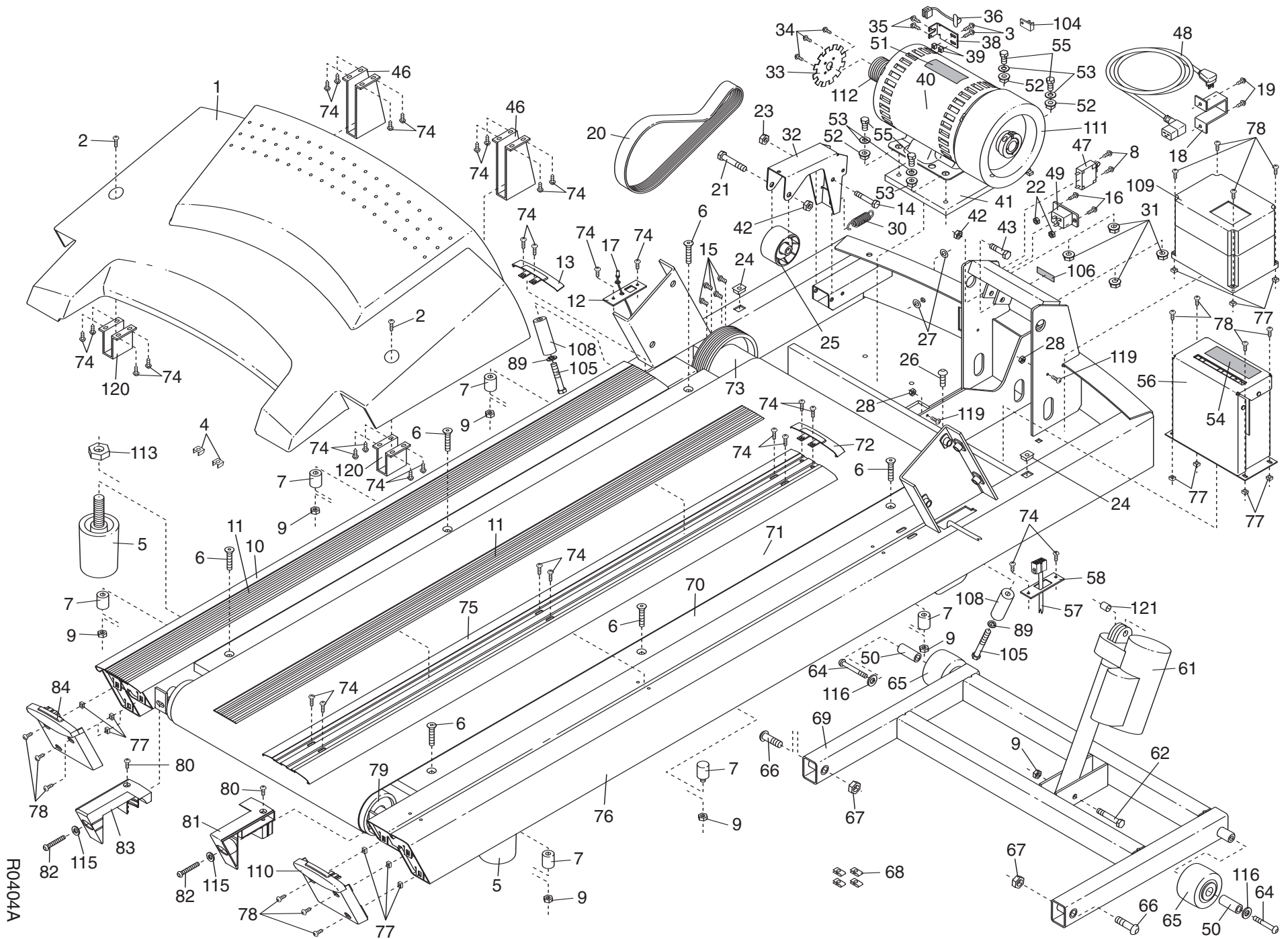

43



R0404A