

EXPLODED DRAWING A—Model No. PFEL1303.3

R1205A

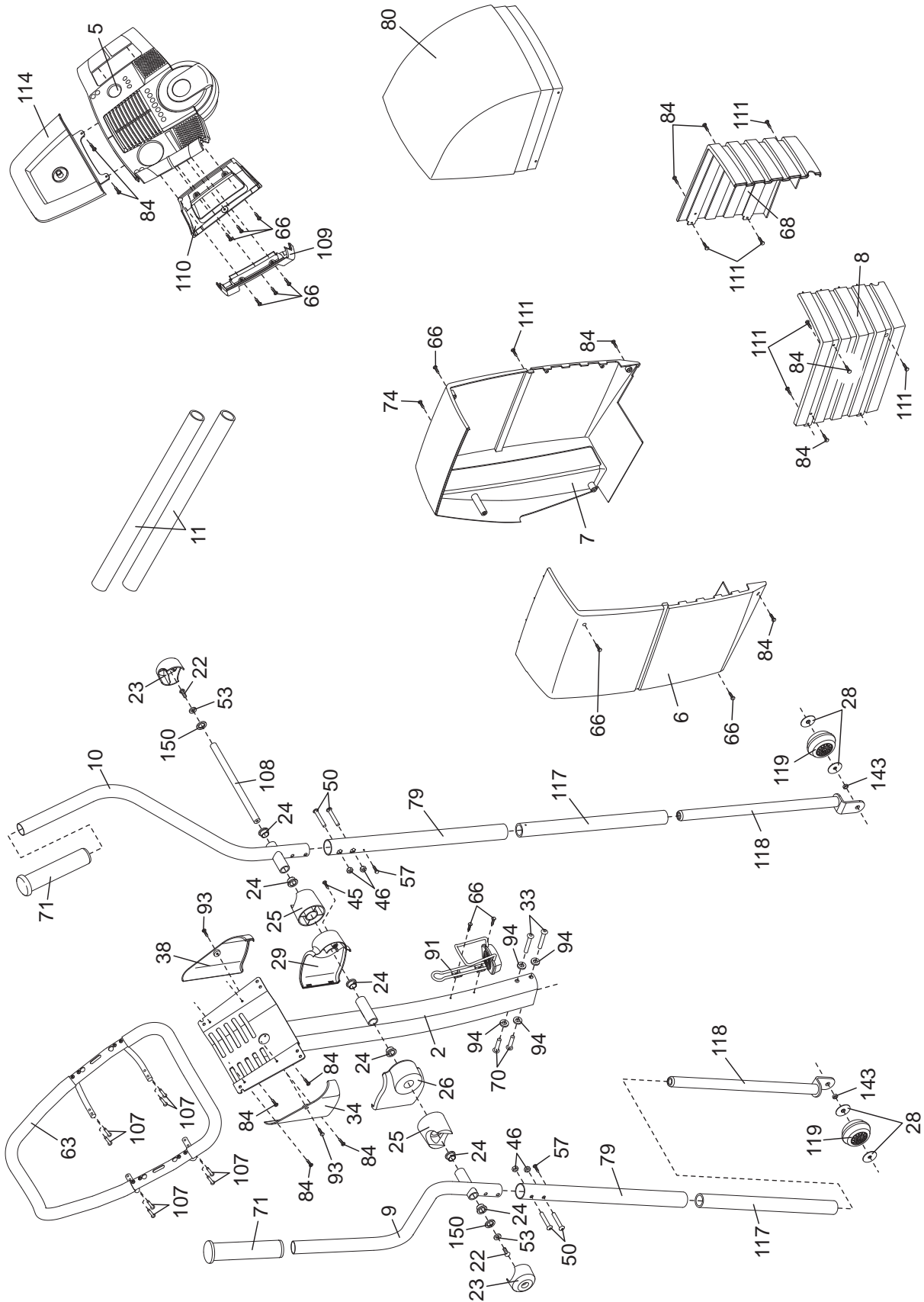

EXPLODED DRAWING B—Model No. PFEL1303.3

R1205A

