

EXPLODED DRAWING—Model No. EPTL14106.0

R1006A

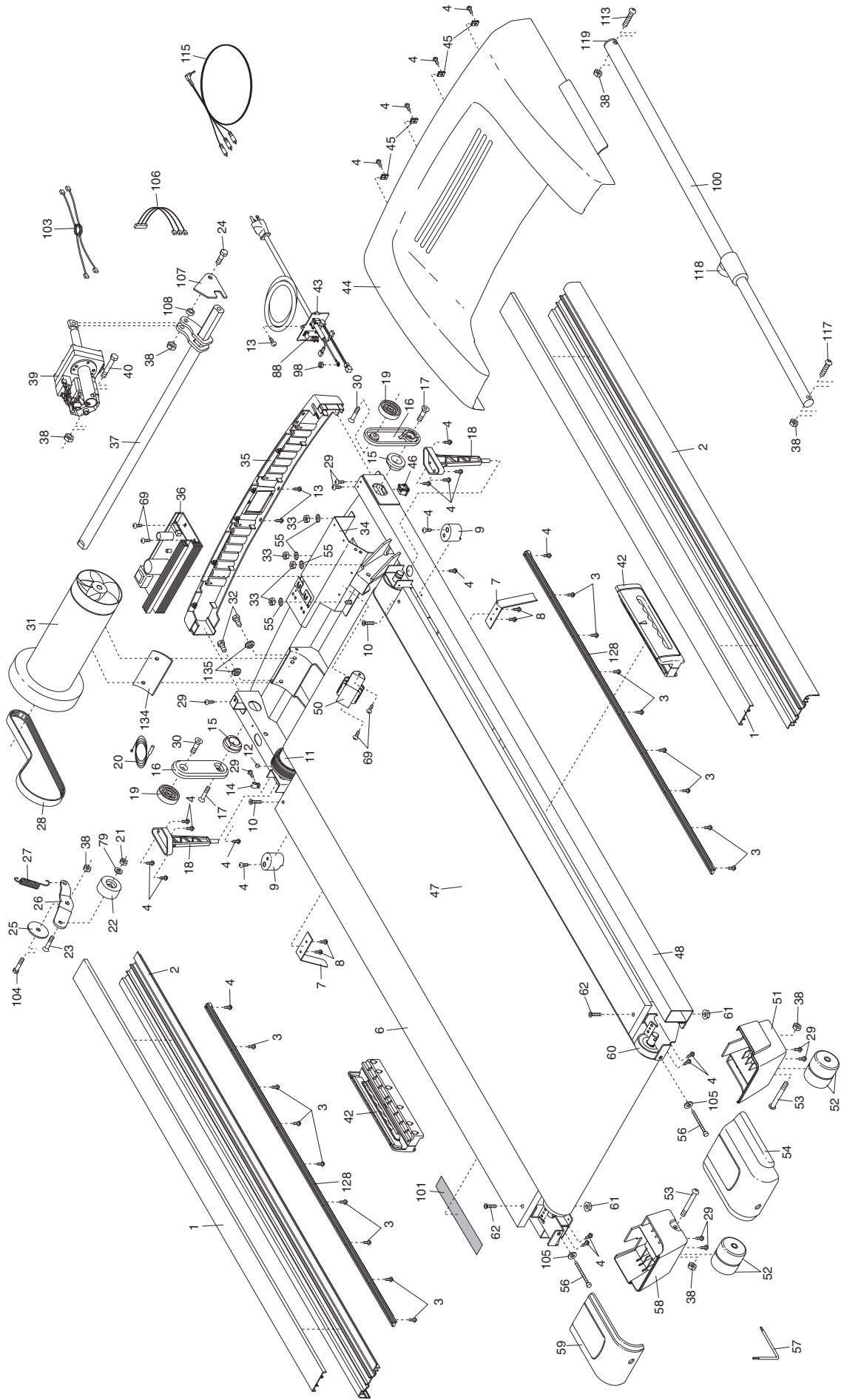

EXPLODED DRAWING—Model No. EPTL14106.0

R1006A

