

EXPLODED DRAWING A

Model No. EPTL69011.1 R0211A

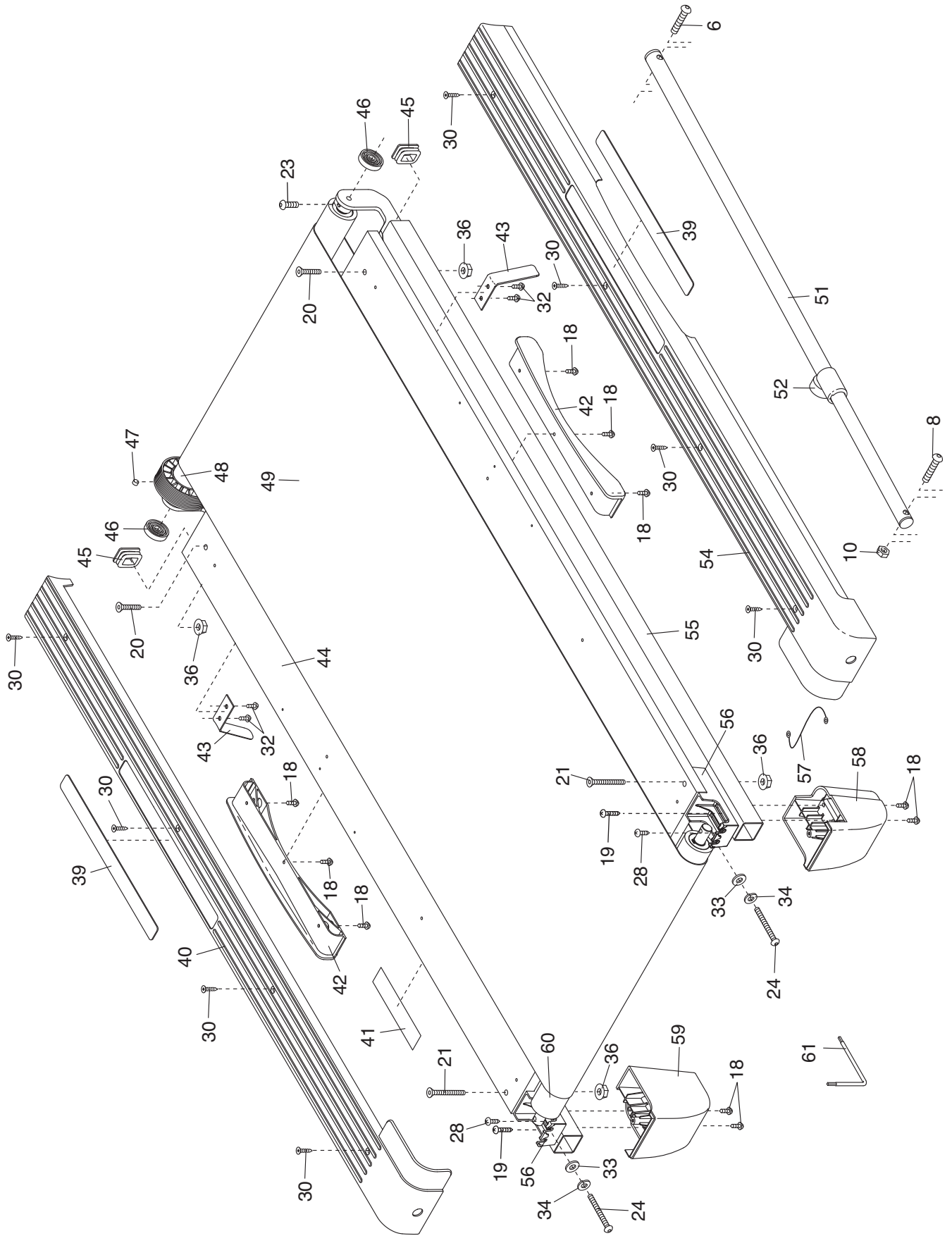

EXPLODED DRAWING B

Model No. EPTL69011.1 R0211A

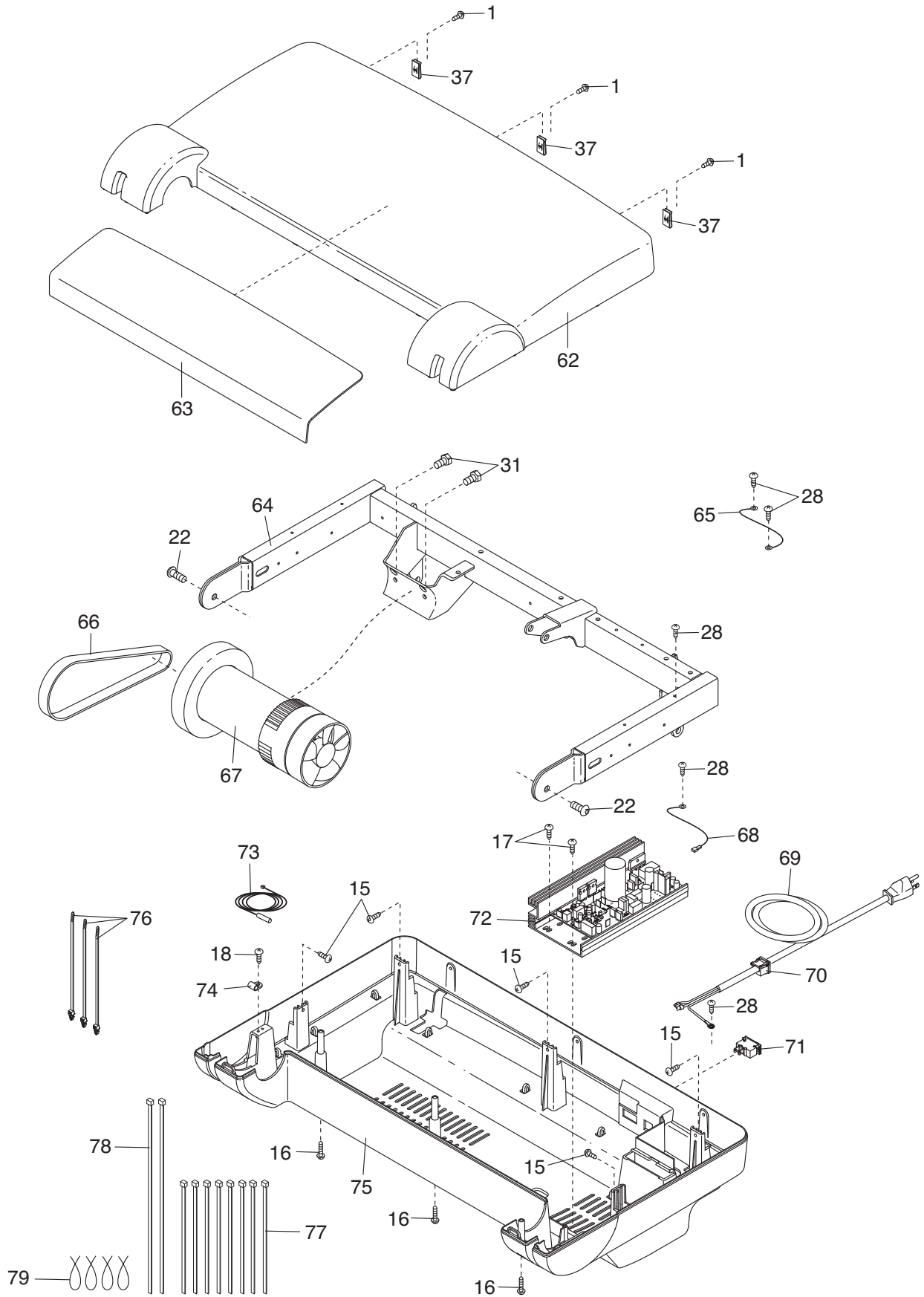

EXPLODED DRAWING C

Model No. EPTL69011.1 R0211A

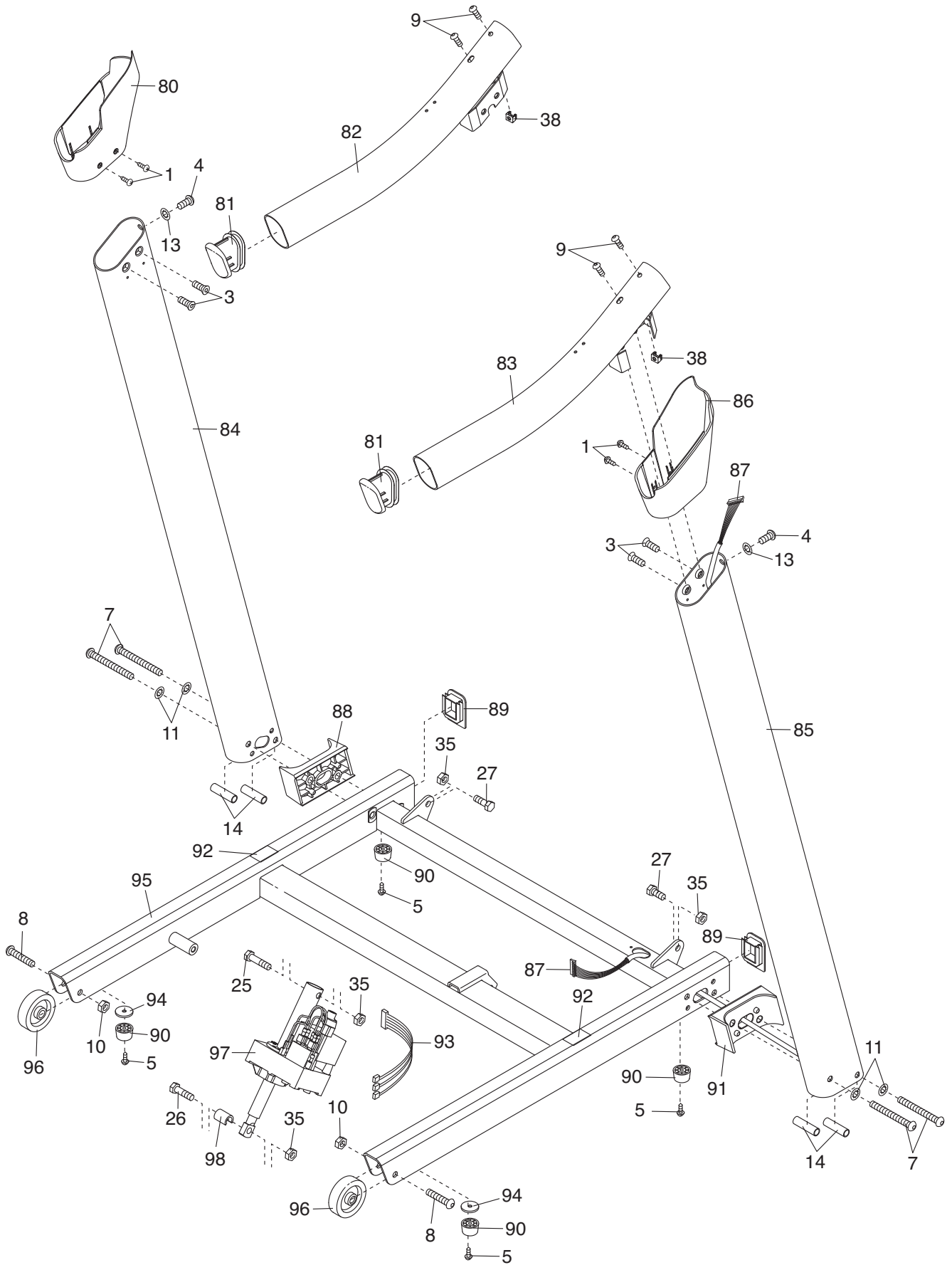

EXPLODED DRAWING D

Model No. EPTL69011.1 R0211A

