

EXPLODED DRAWING A—Model No. EPTL79610.0

R0710A

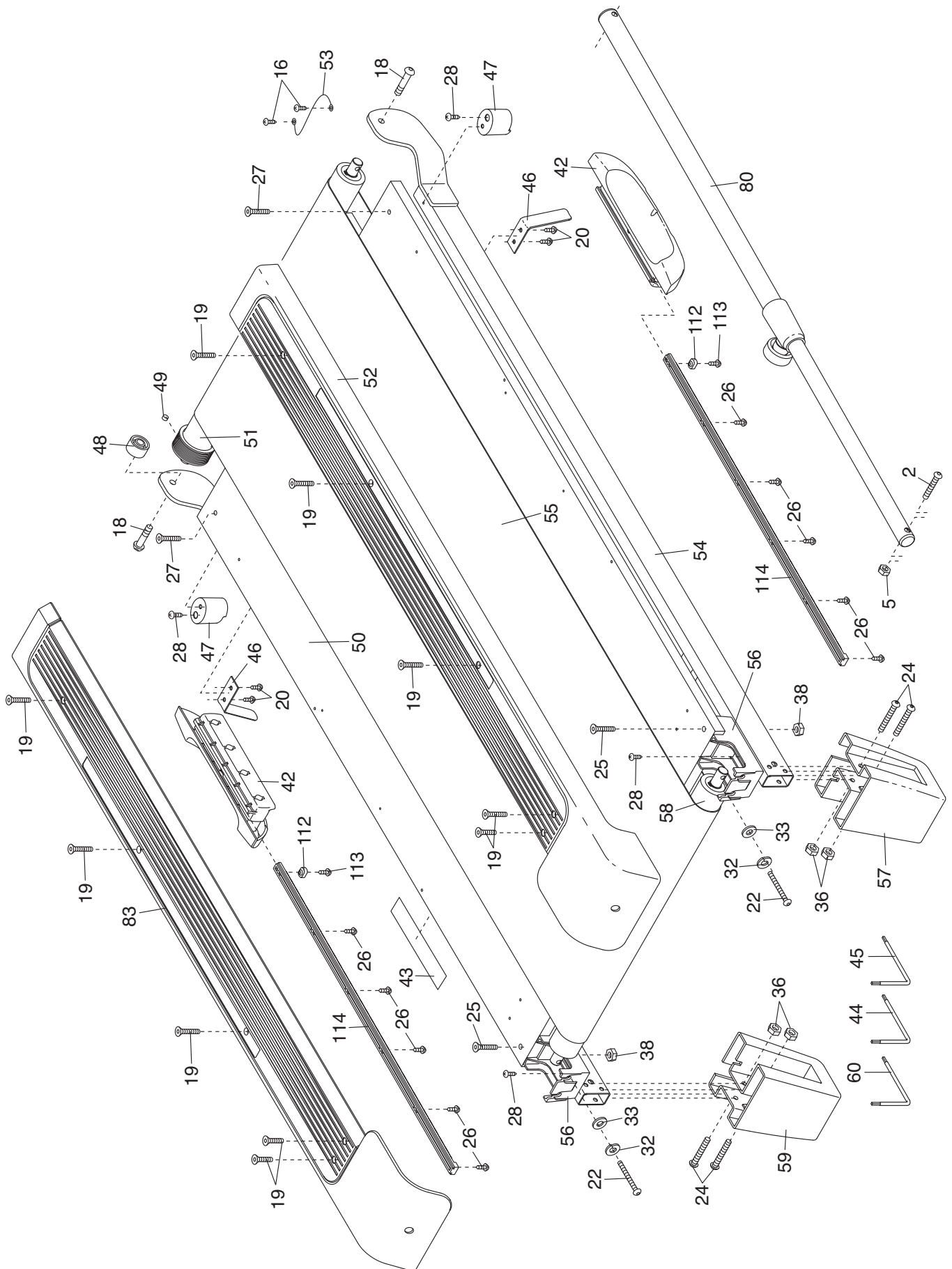

EXPLODED DRAWING B—Model No. EPTL79610.0

R0710A

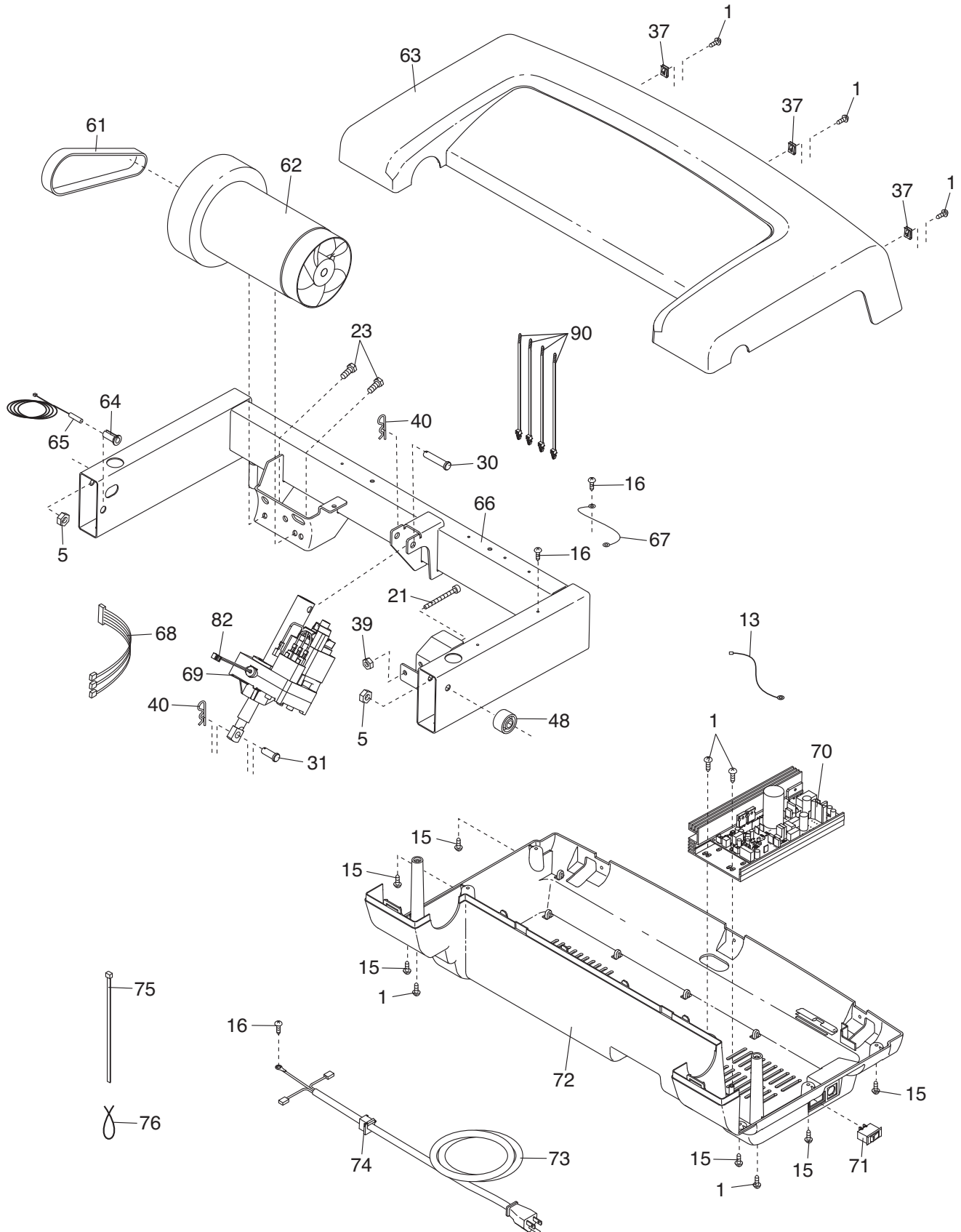

EXPLODED DRAWING C—Model No. EPTL79610.0

R0710A

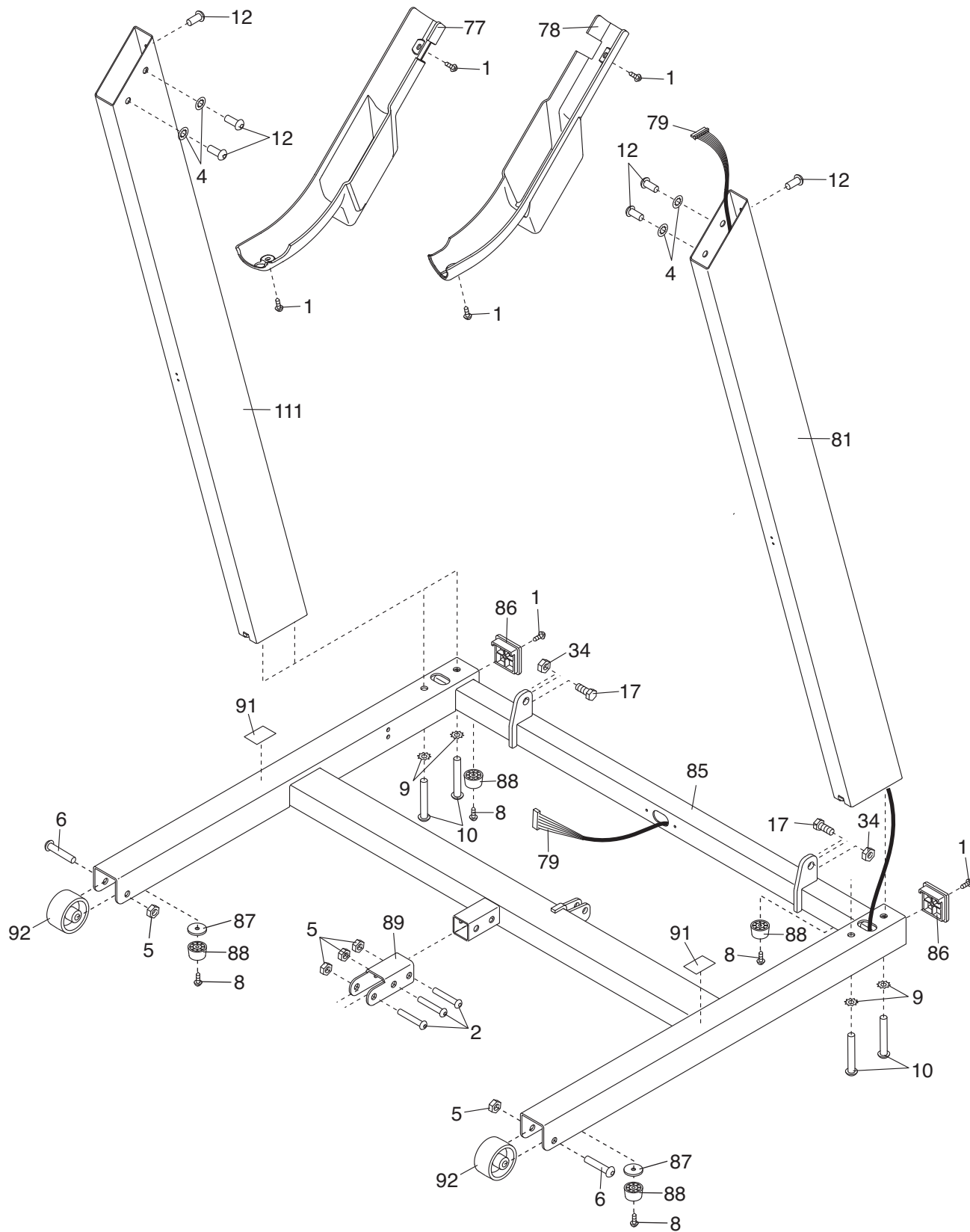

EXPLODED DRAWING D—Model No. EPTL79610.0

R0710A

