

EXPLODED DRAWING A

Model No. EPTL99112.2 R0113A

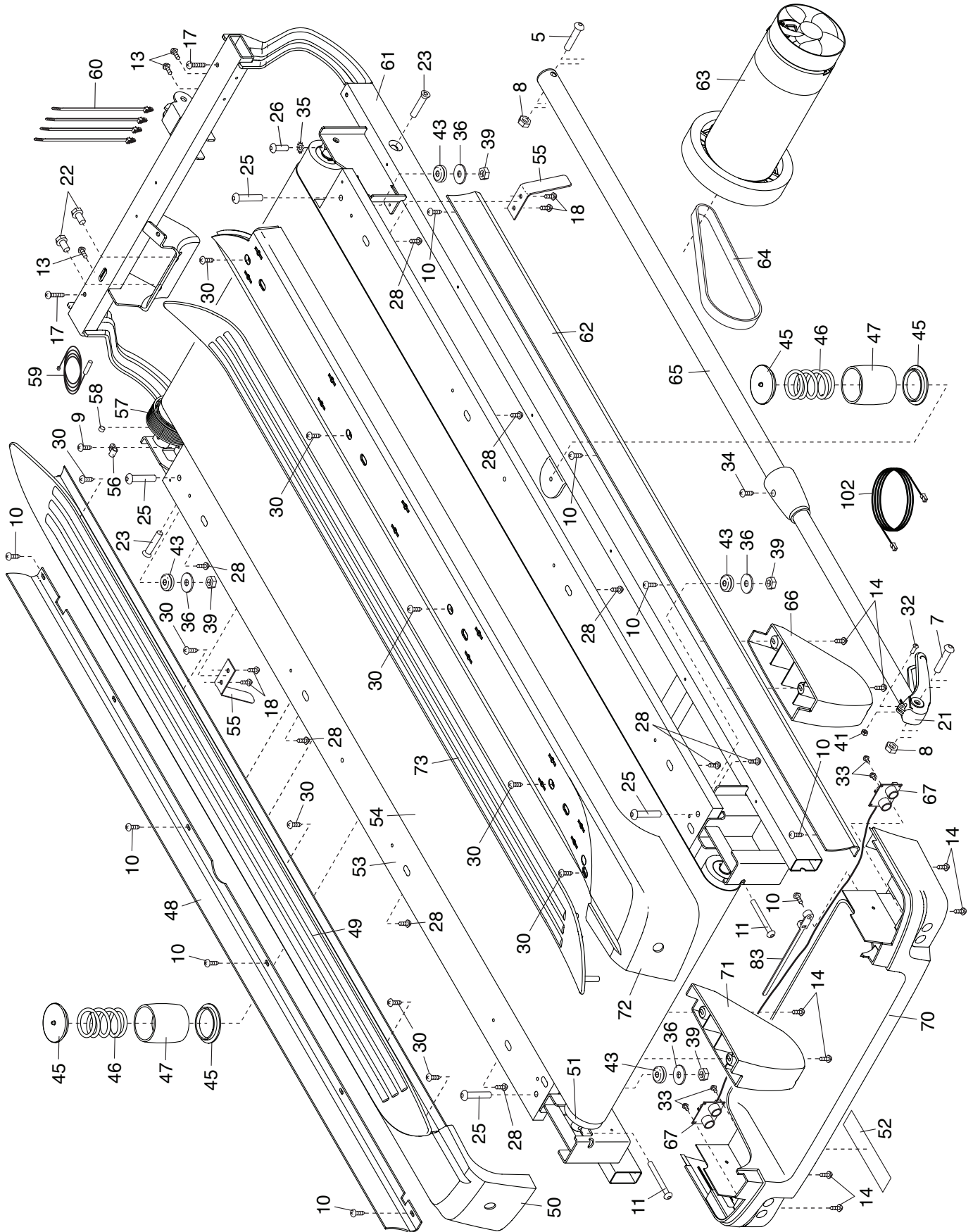

EXPLODED DRAWING B

Model No. EPTL99112.2 R0113A

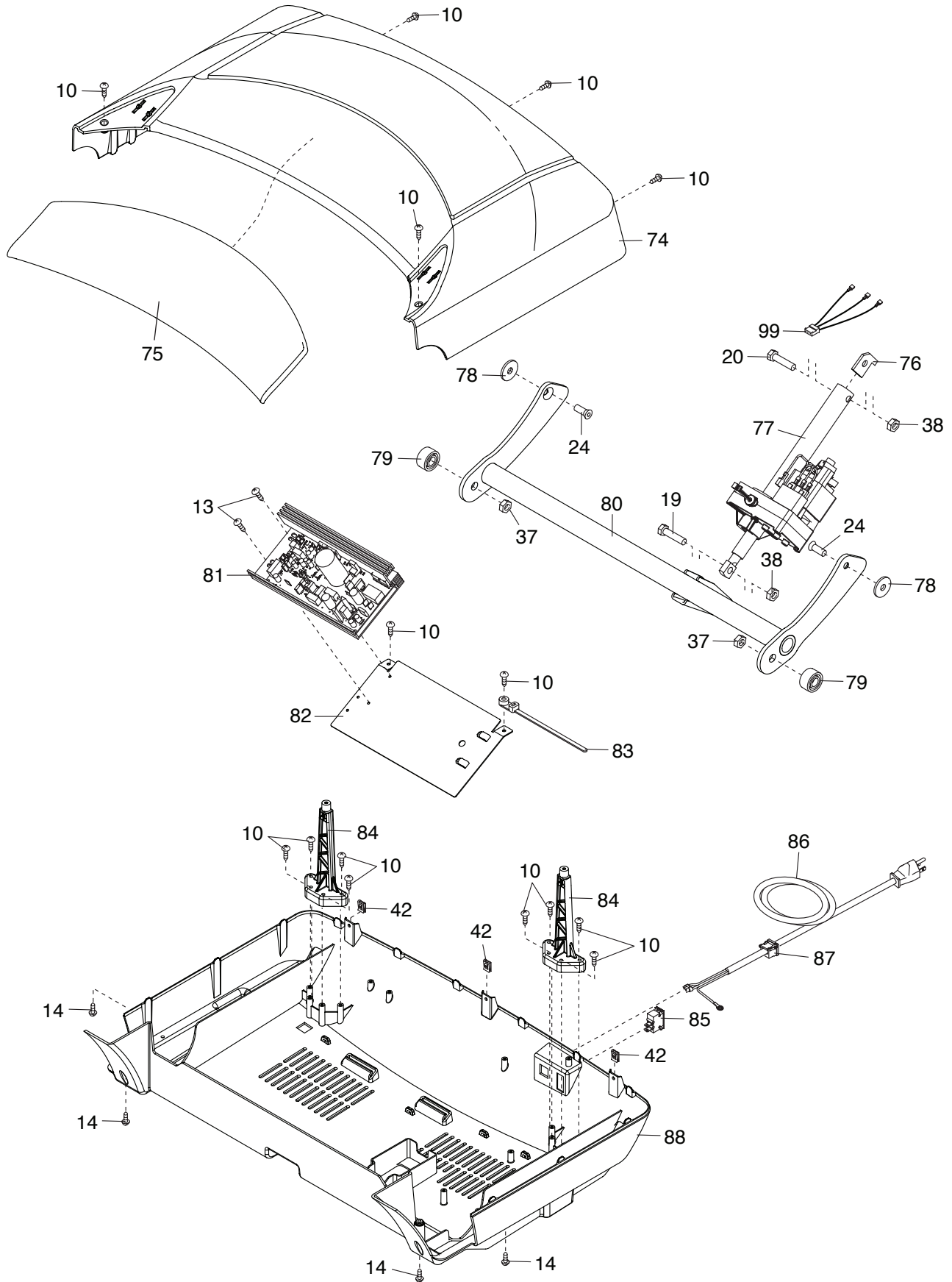

EXPLODED DRAWING C

Model No. EPTL99112.2 R0113A

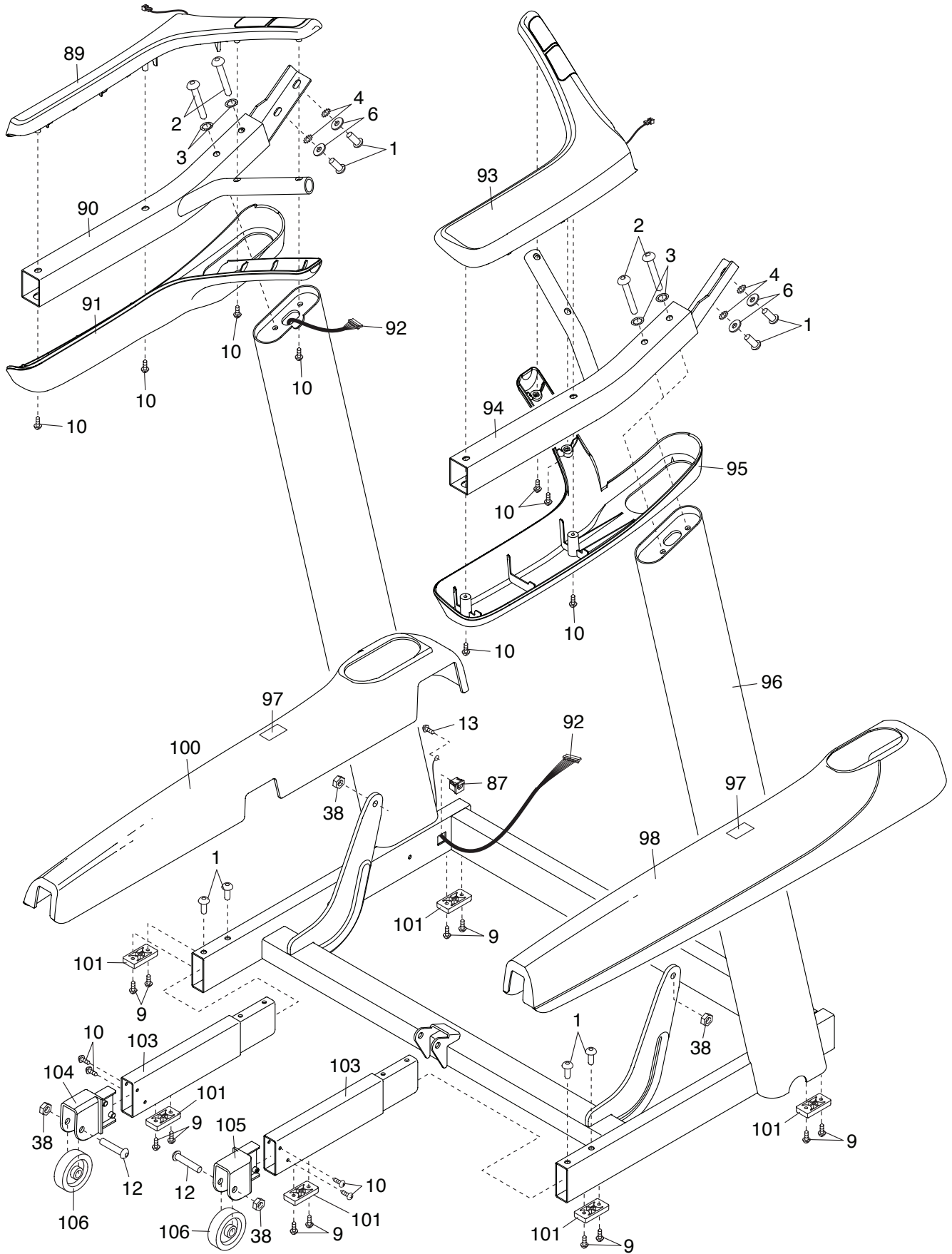

EXPLODED DRAWING D

Model No. EPTL99112.2 R0113A

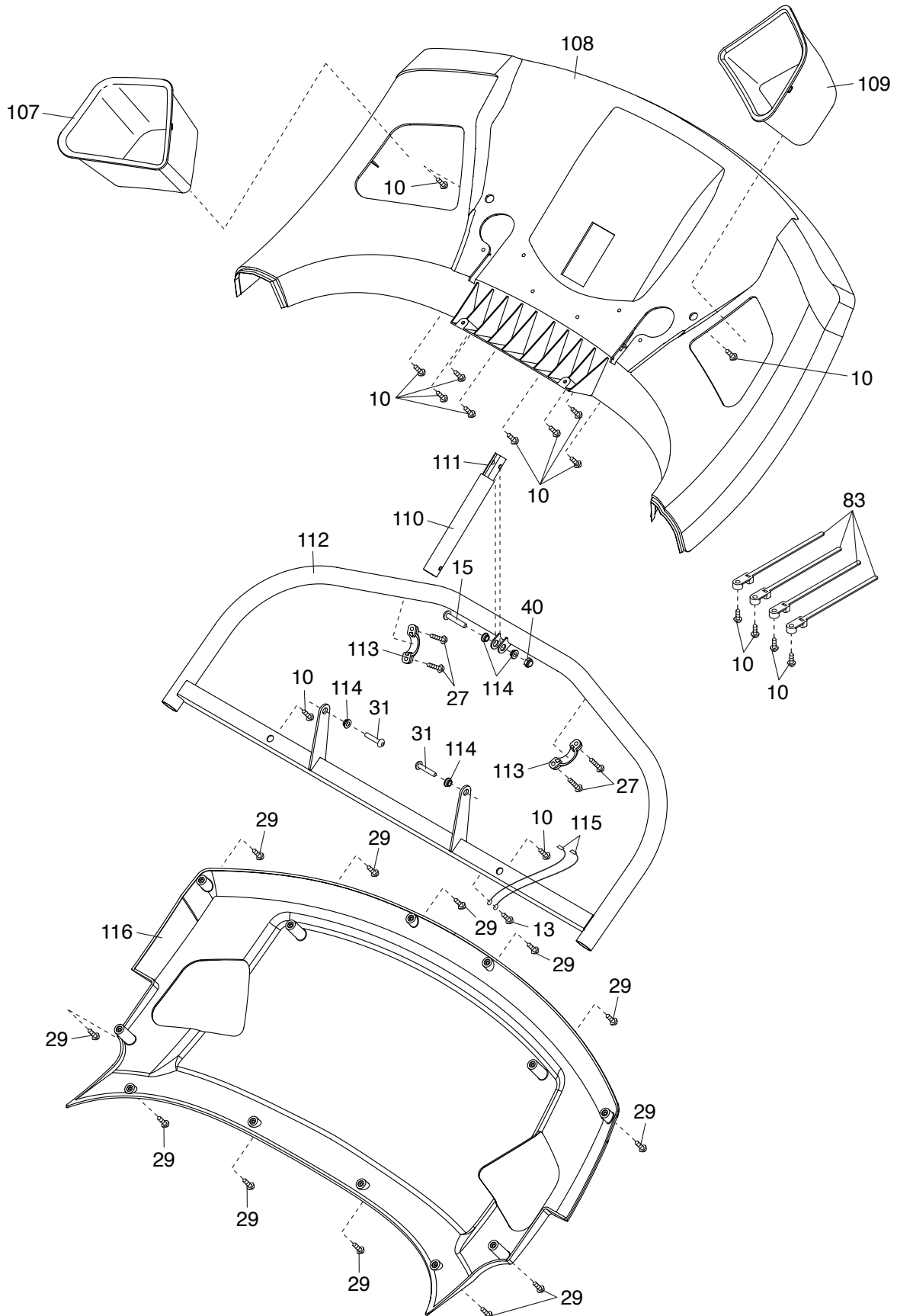

EXPLODED DRAWING E

Model No. EPTL99112.2 R0113A

