

# EXPLODED DRAWING A

Model No. F611.1 R0116A

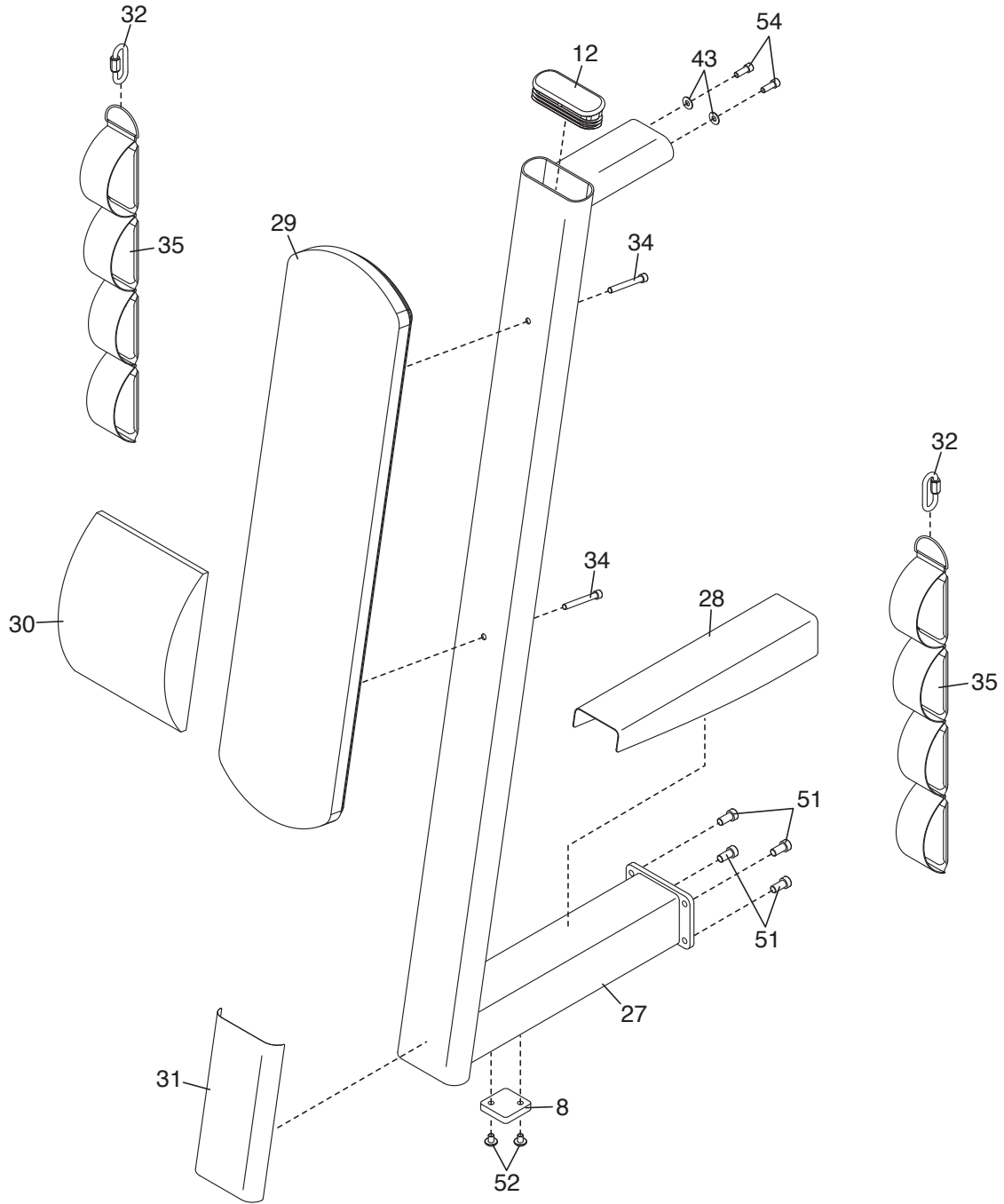

# EXPLODED DRAWING B

Model No. F611.1 R0116A

