

EXPLODED DRAWING A

Model No. FMEX82410.1 R0213B

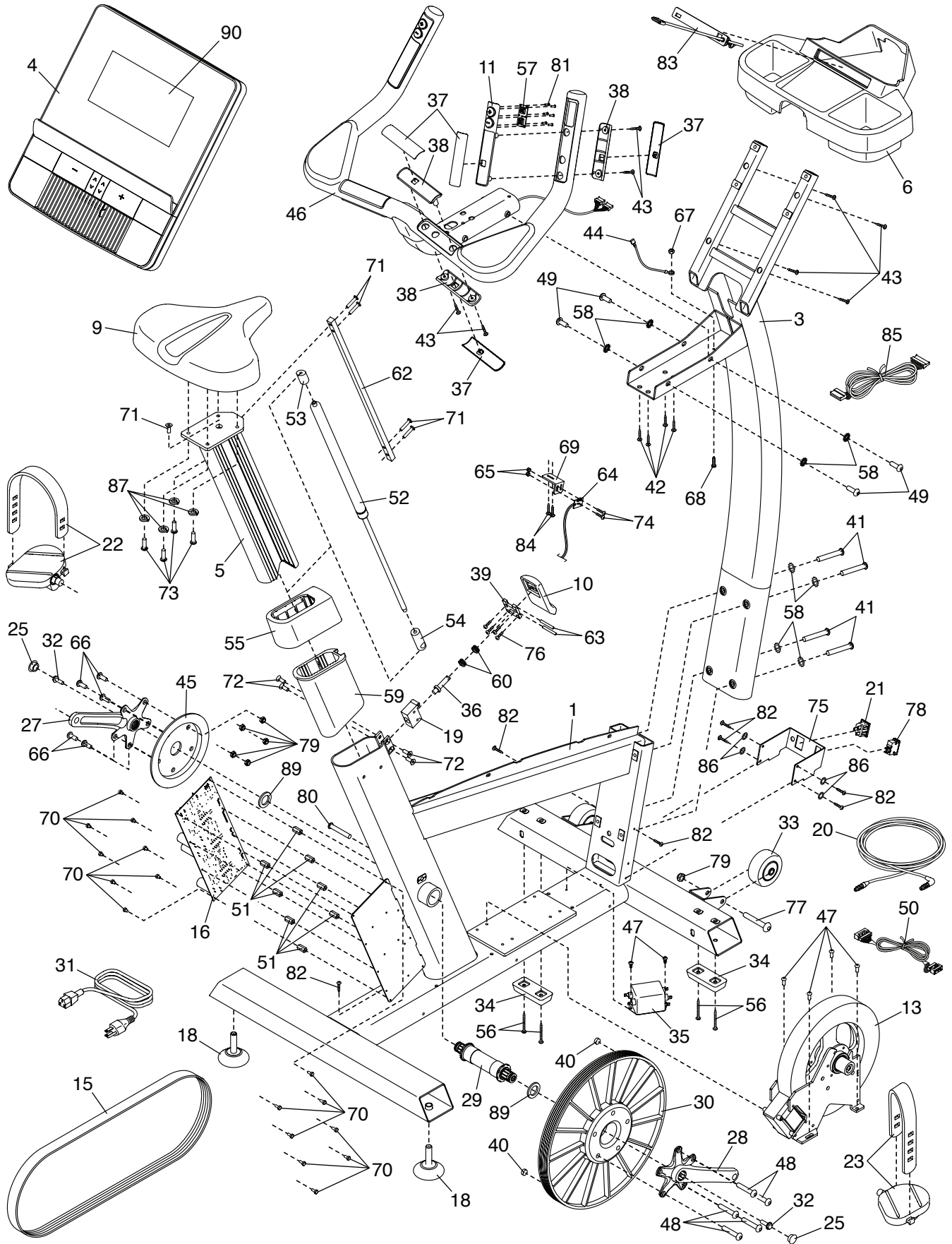

EXPLODED DRAWING B

Model No. FMEX82410.1 R0213B

