

EXPLODED DRAWING A

Model No. FMTK74810.5 R0613A

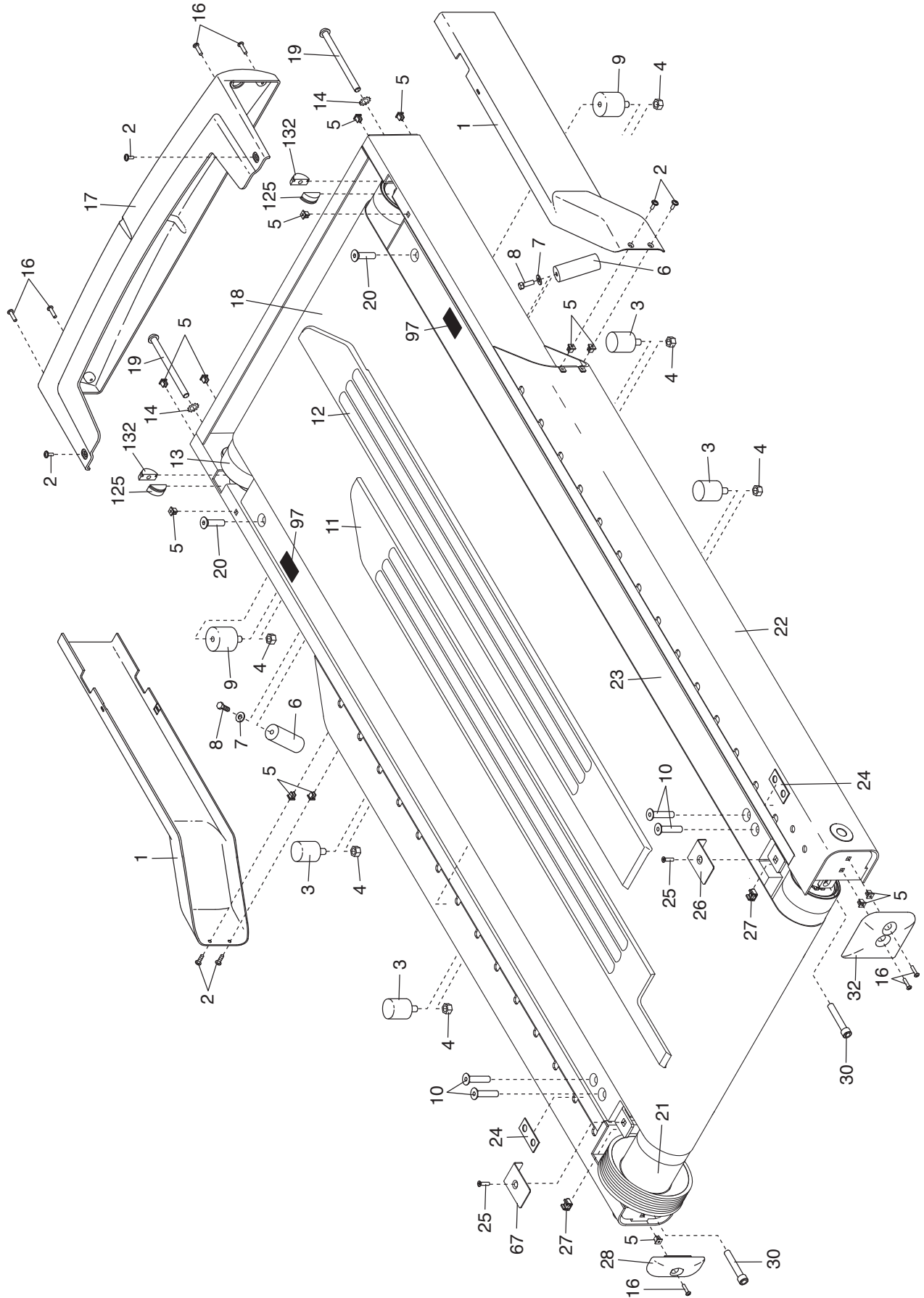

EXPLODED DRAWING B

Model No. FMTK74810.5 R0613A

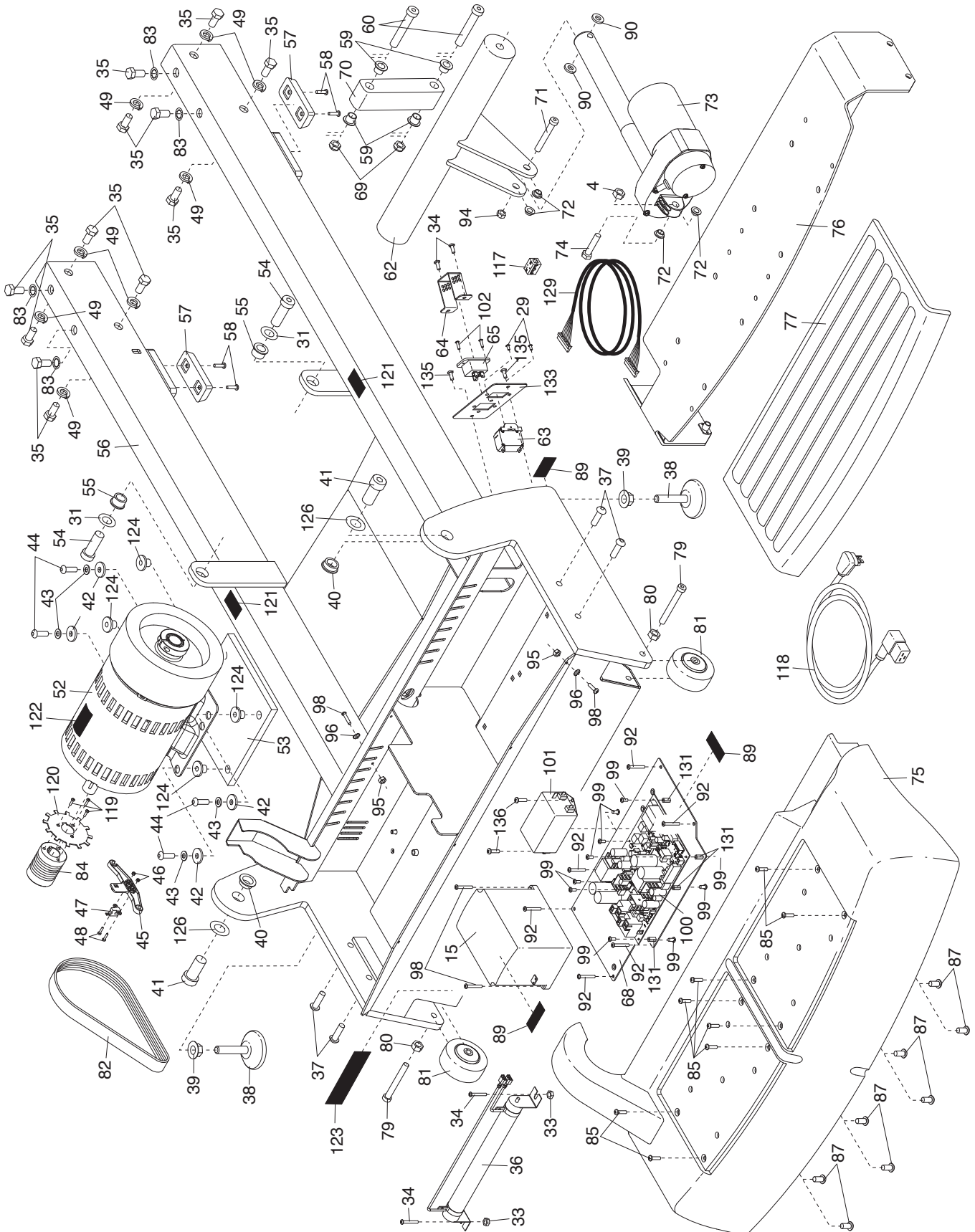

EXPLODED DRAWING C

Model No. FMTK74810.5 R0613A

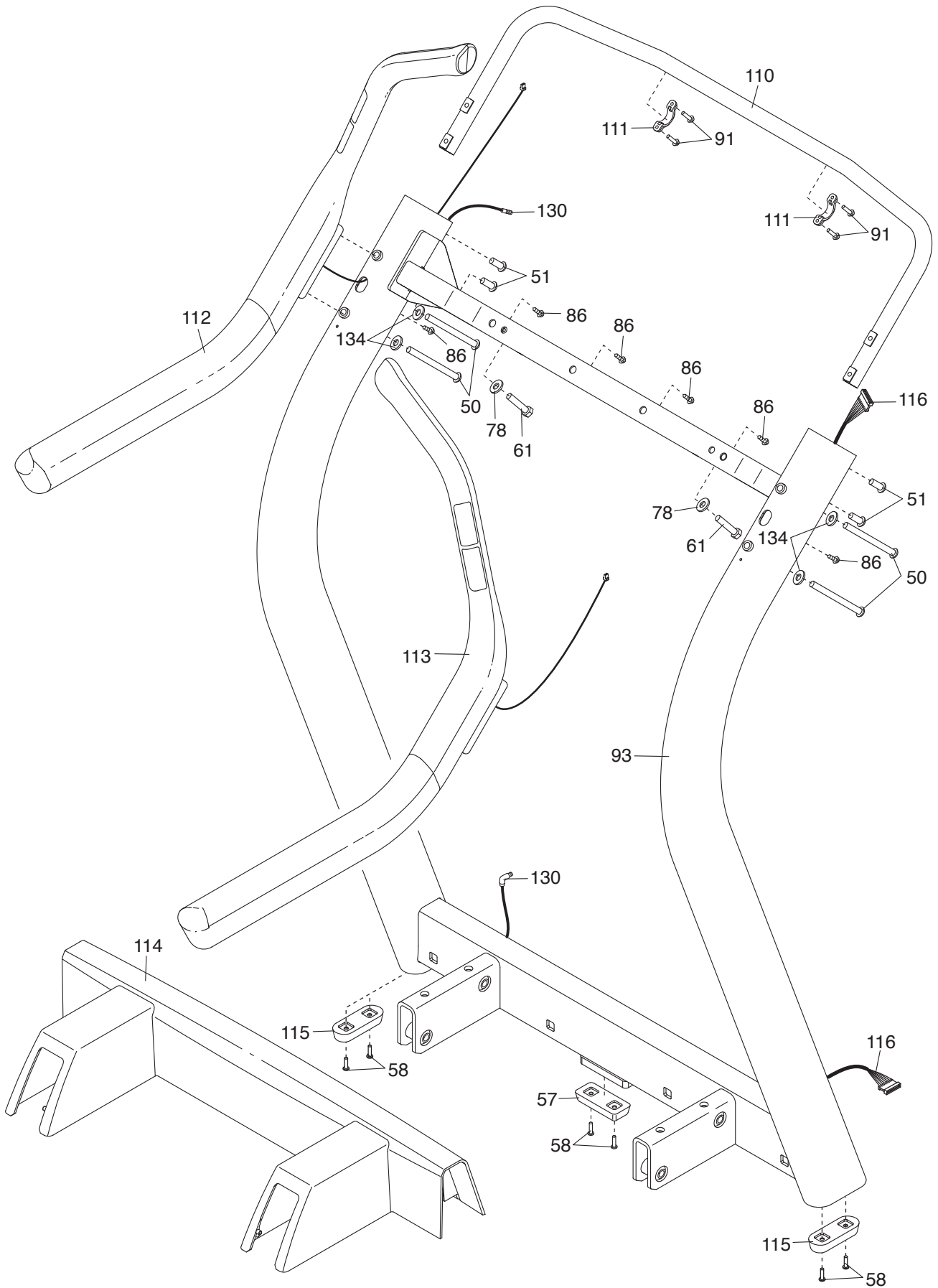

EXPLODED DRAWING D

Model No. FMTK74810.5 R0613A

