

EXPLODED DRAWING A

Model No. FMTL39813.6 R0416A

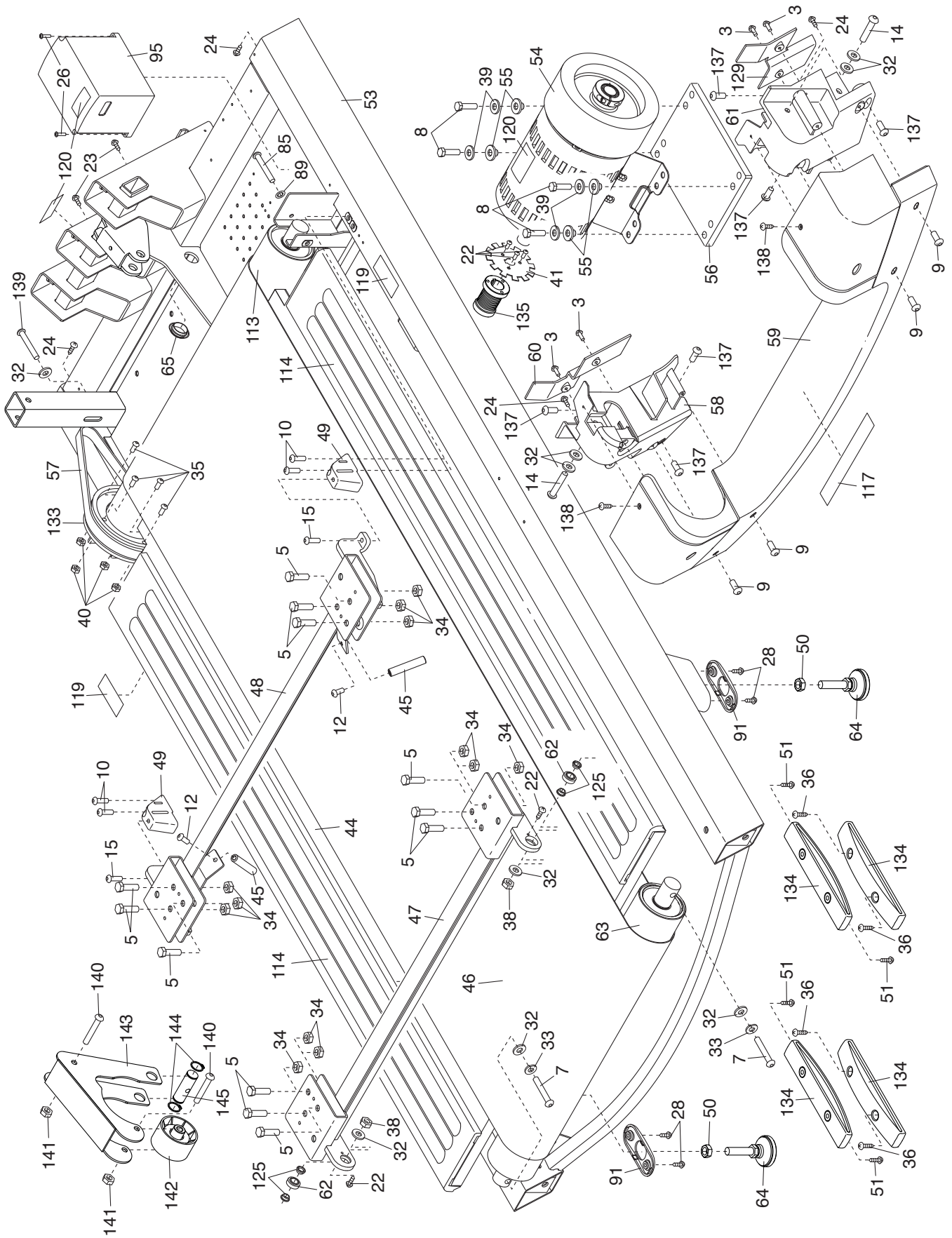

EXPLODED DRAWING B

Model No. FMTL39813.6 R0416A

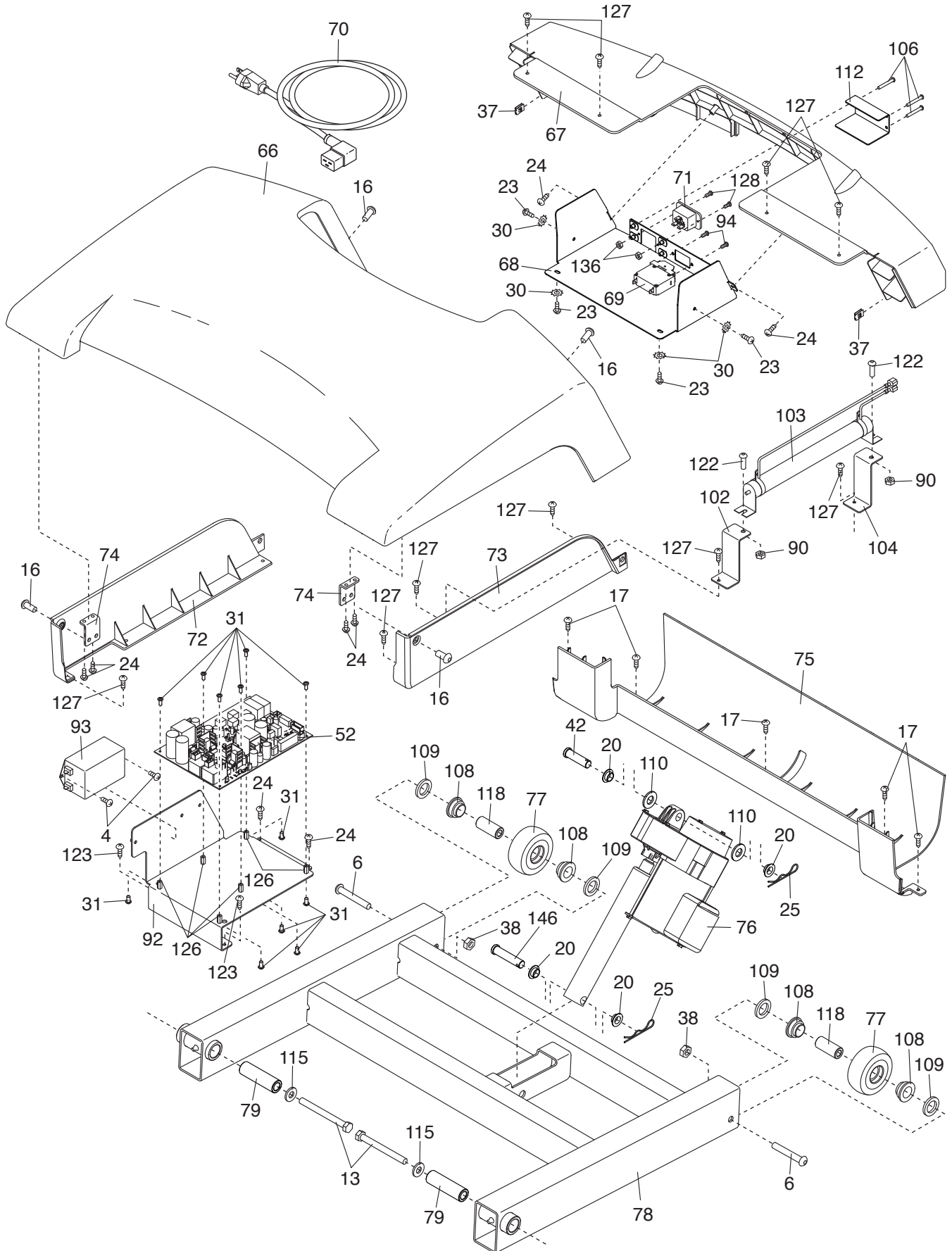

EXPLODED DRAWING C

Model No. FMTL39813.6 R0416A

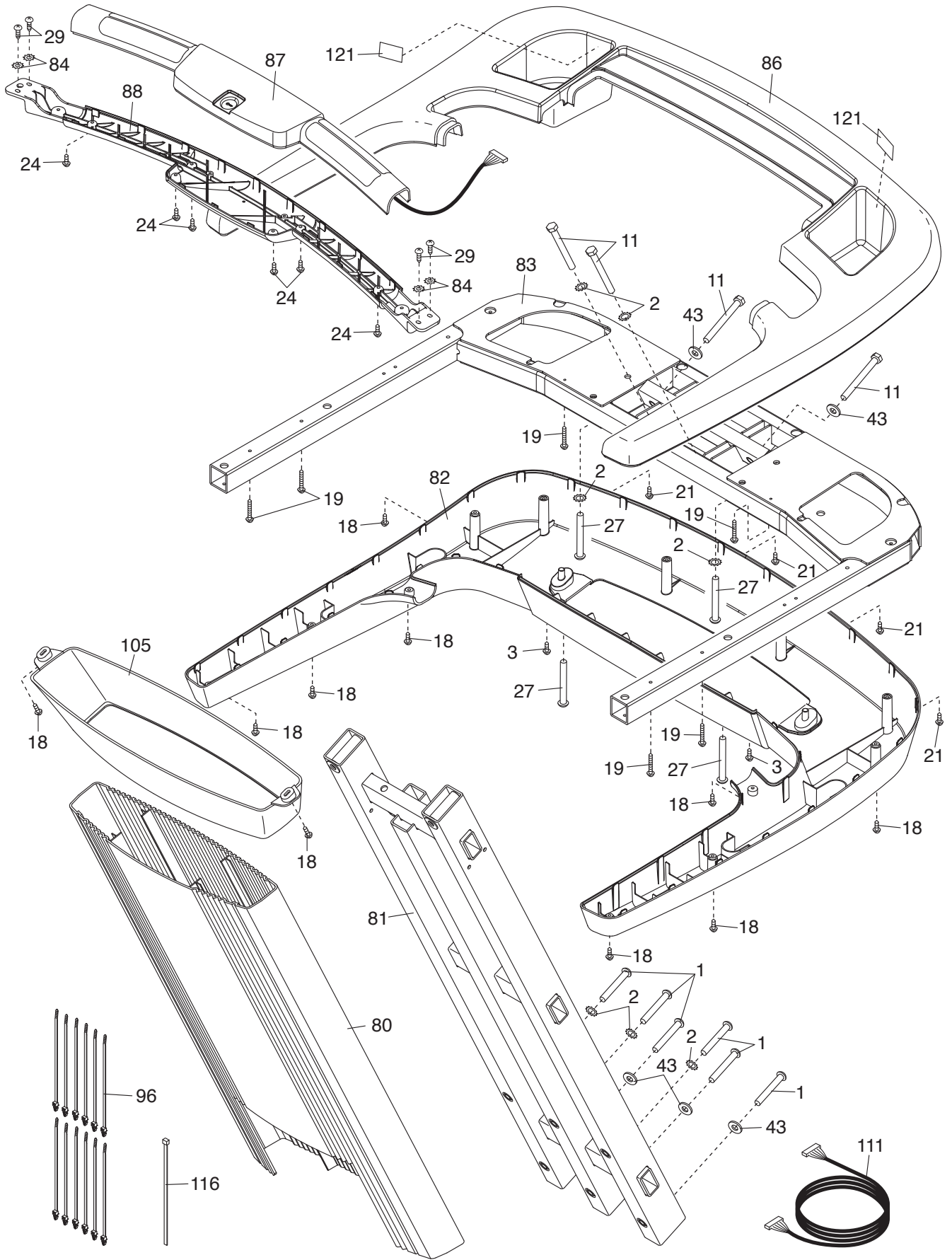

EXPLODED DRAWING D

Model No. FMTL39813.6 R0416A

