

EXPLODED DRAWING A

Model No. FMTL70810.0 R0312A

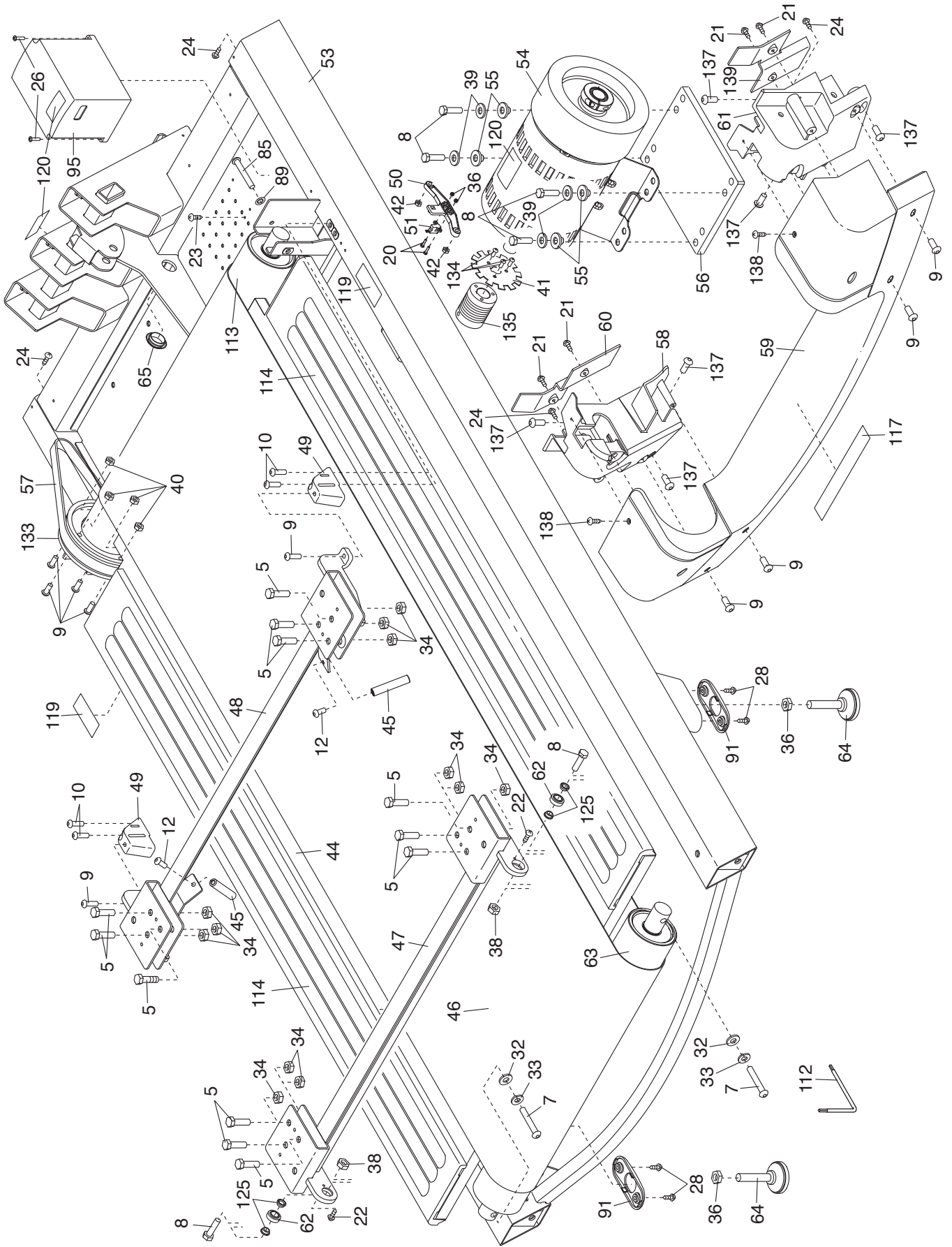

EXPLODED DRAWING B

Model No. FMTL70810.0 R0312A

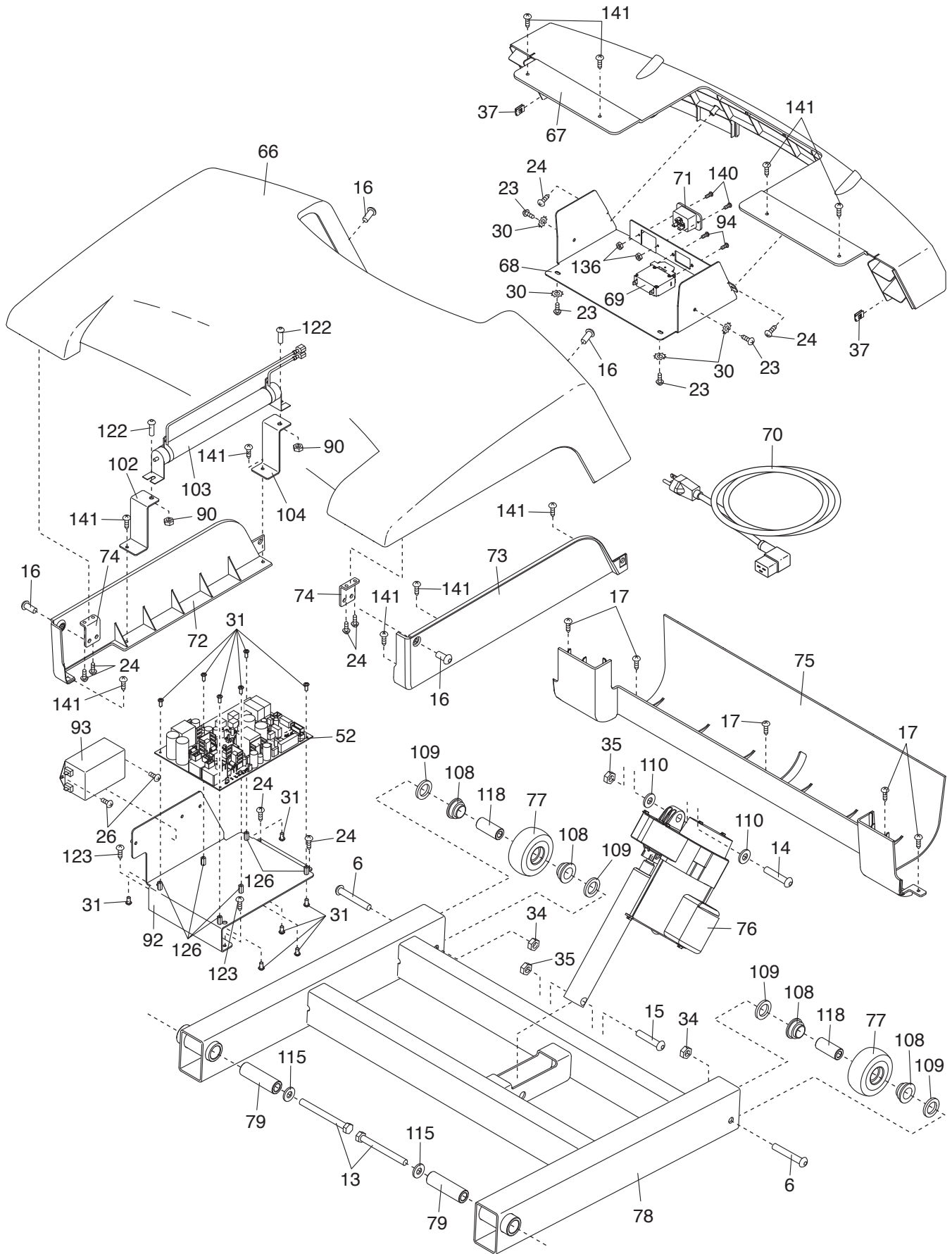

EXPLODED DRAWING C

Model No. FMTL70810.0 R0312A

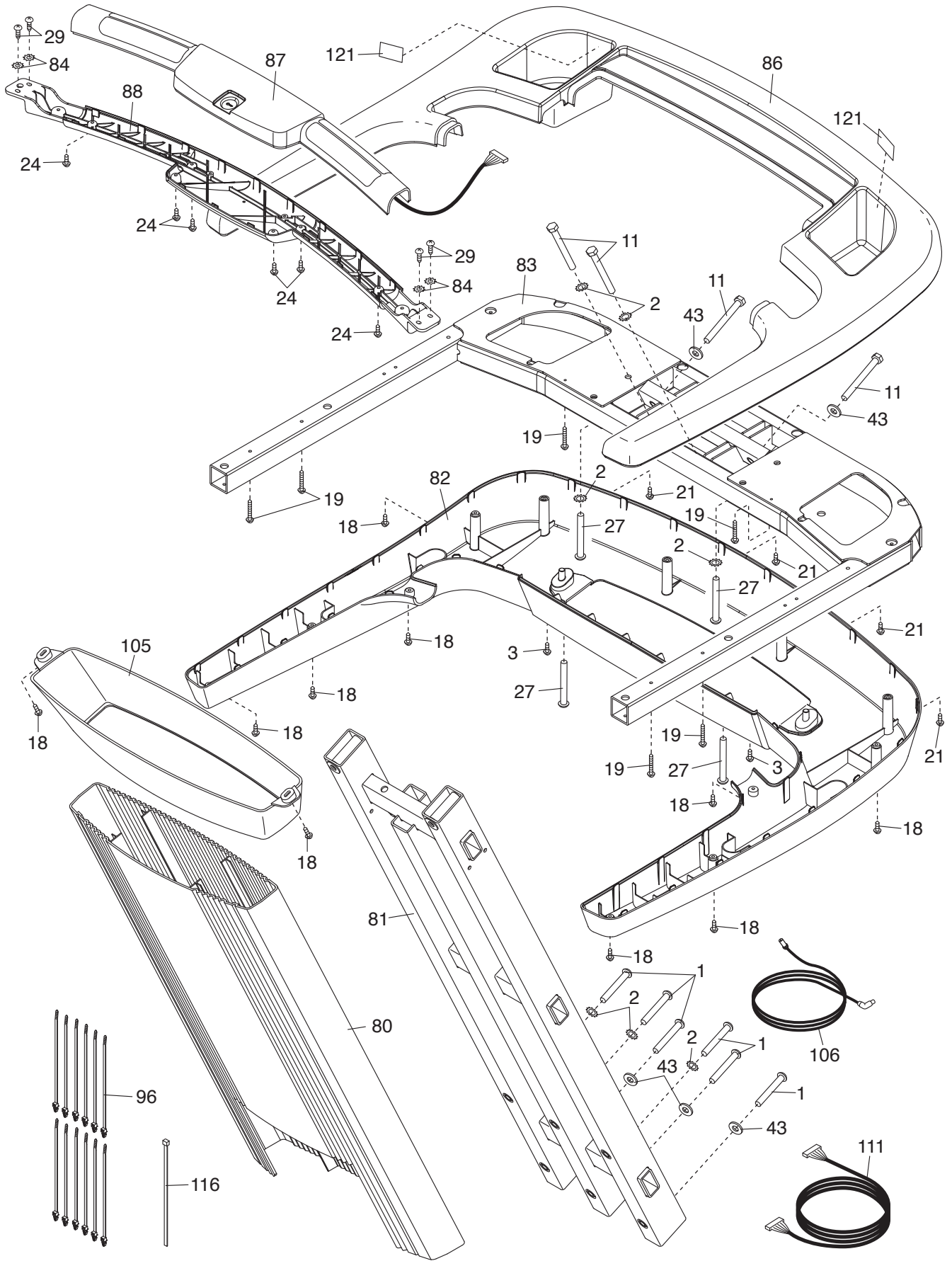

EXPLODED DRAWING D

Model No. FMTL70810.0 R0312A

