

DISEGNO ESPLOSO A

N° del Modello GETL80814.0 R0414A

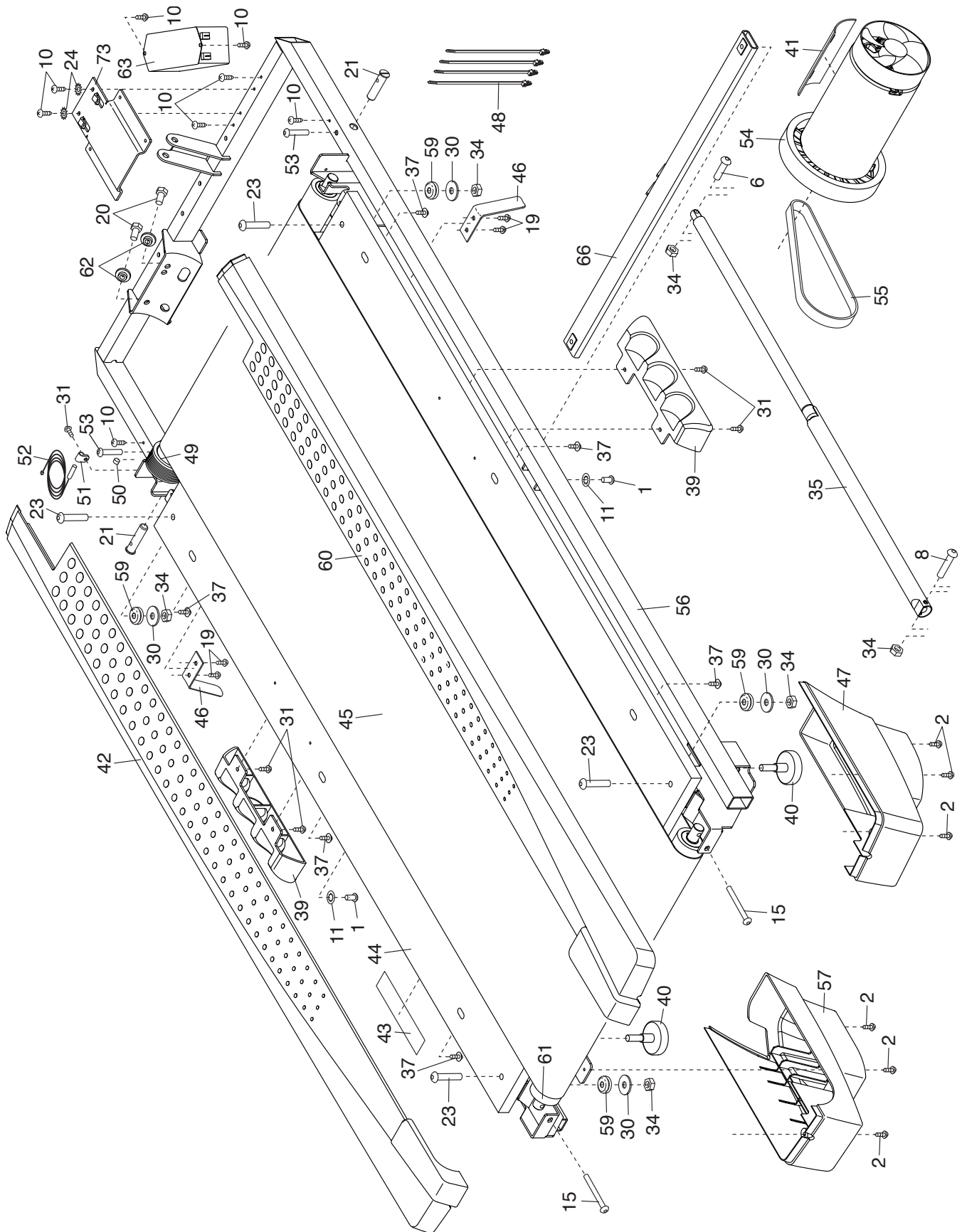

DISEGNO ESPLOSO B

N° del Modello GETL80814.0 R0414A

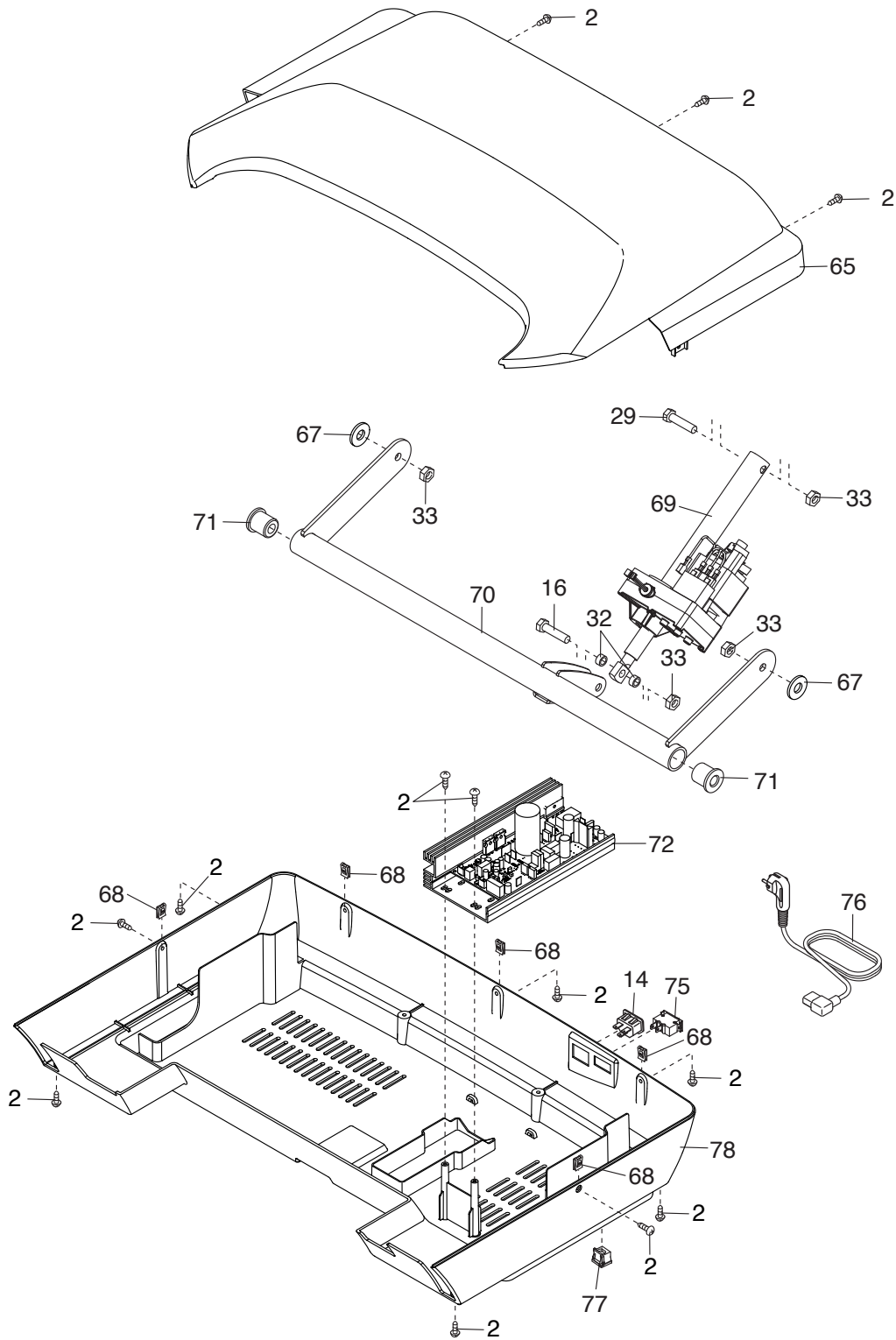

DISEGNO ESPLOSO C

N° del Modello GETL80814.0 R0414A

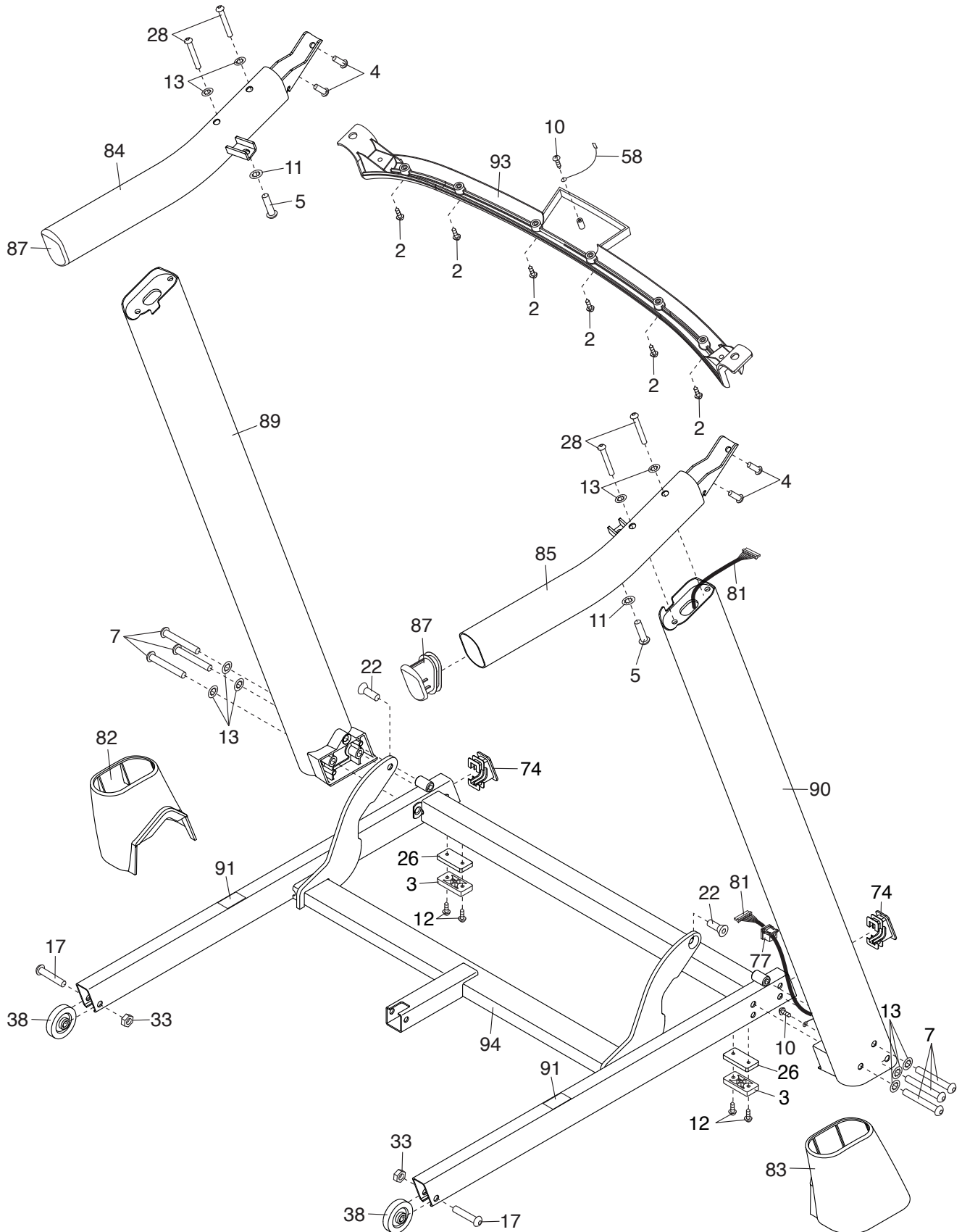

DISEGNO ESPLOSO D

N° del Modello GETL80814.0 R0414A

