

# PART LIST—Model No. GFTL13804.1

R0505A

To locate the parts listed below, see the EXPLODED DRAWING attached in the centre of this manual.

Key No.	Qty.	Description	Key No.	Qty.	Description
1	1	Left Foot Rail	51	2	Static Decal
2	12	Foot Rail Screw	52	10	3/4" Tek Screw
3	2	Isolator Bolt (Top)	53	1	Belly Pan Clip
4	2	Isolator Decal	54	1	Belly Pan
5	2	Isolator Top Cap	55	1	Releasable Tie
6	2	Gray Isolator Spring	56	1	Clamp Screw
7	2	Isolator	57	1	Tie Holder Clamp
8	2	Isolator Bottom Cap	58	1	Cable Tie
9	2	Isolator Bracket Cover	59	1	Frame
10	2	Isolator Bracket	60	1	Right Rear Foot
11	4	Isolator Bracket Bolt	61	1	Chest Pulse Strap
12	2	Isolator Bolt	62	2	Rear Roller Adj, Bolt
13	1	Walking Platform	63	1	Rear Roller
14	2	Belt Guide	64	1	Hex Key
15	4	Belt Guide Screw	65	1	5/32" Hex Key
16	2	Walking Platform Screw (Rear)	66	1	Left Rear Foot
17	2	Frame Pivot Bolt	67	1	Right Foot Rail
18	1	Front Roller/Pulley	68	1	Walking Belt
19	1	Magnet	69	2	Warning Decal
20	9	Pivot Nut	70	2	Blue Isolator Spring
21	2	Pivot Bushing	71	1	Pulse Bar
22	1	Reed Switch	72	1	UK Adaptor
23	1	Reed Switch Screw	73	1	Splitter
24	1	Reed Switch Clip	74	1	Wire Harness
25	2	Lift Pivot Bolt	75	1	Right Top Endcap
26	2	Motor Washer	76	4	Console Bolt
27	1	On/Off Switch	77	4	Internal Star Washer
28	1	Motor Pulley	78	5	Hood Cover Screw
29*	1	Idler Arm Assembly	79	2	Upright Spacer
30	1	Idler Arm Pivot Bolt	80	1	Right Upright
31	1	Motor	81	1	Left Top Endcap
32	1	Idler Arm	82	1	Latch Assembly
33	1	Lift Frame	83	1	Controller Wire
34	1	Motor Pivot Nut	84	1	Left Upright
35	2	Walking Platform Nut	85	2	CD Holder
36	1	Pulse Receiver	86	4	Upright Bolt
37	1	Incline Motor	87	8	U-Nut
38	4	Incline Motor Bolt	88	2	Upright Endcap (Lower)
39	2	1/4" Washer	89*	2	Extension Leg Assembly
40	1	Motor Isolator	90	2	Wheel Bolt
41	1	Front Roller Adj. Bolt	91	2	Warning Decal
42	2	Walking Platform Screw (Front)	92	2	Extension Leg
43	1	Transformer	93	1	Small Nut
44	3	Hood Screw	94	2	Wheel
45	1	Hood Cover	95	2	Levelling Foot
46	1	Hood Decal	96	4	Extension Leg Bolt
47	1	Controller Bracket	97	1	Upright Base
48	1	Controller	98	1	Photo Switch
49	2	Power Cord	99	2	Base Pad
50	1	Receptical	100	2	Upright Base Endcap

Key No.	Qty.	Description	Key No.	Qty.	Description
101	1	Console Base	129	2	Front Isolator Screw
102	1	Pulse Wire	130	1	Optic Disk
103	8	Ground Screw/Choke Screw	131	1	iFIT.com Wire
104	1	Key Clip	132	1	Filter Wire
105	2	Fan Screw	133	1	Photo Switch Wire
106	1	Fan	134	2	Latch Screw
107	1	Console	135	2	1" Tek Screw
108	51	Screw	136	1	Pulley Nut
109	1	Left Tray	137	1	Pulley Washer
110	1	CD Console	138	1	Idler Pulley
111	1	Right Tray	139	1	Chest Pulse Monitor
112	1	iFIT.com Audio Cable	140	1	Pulley Bolt
113	1	iFIT.com Jack	141	3	Ferrite Box
114	2	Motor Bolt	142	1	Filter
115	1	Photo Switch Screw	143	1	Circuit Breaker
116	1	Console Base Frame	144	1	Edge Guard
117	1	Left Handgrip (Top)	#	1	8" Green Wire, F/Ring
118	1	Photo Switch Nut	#	2	6" Green Wire, F/Ring
119	1	Left Bottom Handgrip	#	1	4" Green Wire, F/Ring
120	1	Right Handgrip (Top)	#	1	10" White Wire, 2F
121	1	Right Bottom Handgrip	#	1	10" Blue Wire, 2F
122	1	Access Door	#	1	4" Blue Wire, 2F
123	1	Hood	#	1	4" Black Wire, 2F
124	1	Console Back	#	1	User's Manual
125	1	Photo Switch Star Washer			
126	3	Roller Star Washer			
127	4	Upright Star Washer			
128	2	Front Isolator			

\*Includes all parts shown in the box

#These parts are not illustrated

Specifications are subject to change without notice.

# EXPLODED DRAWING—Model No. GFTL13804.1

R0505A

To identify parts shown on this EXPLODED DRAWING, see the PART LIST on pages 34 and 35 of the user's manual.

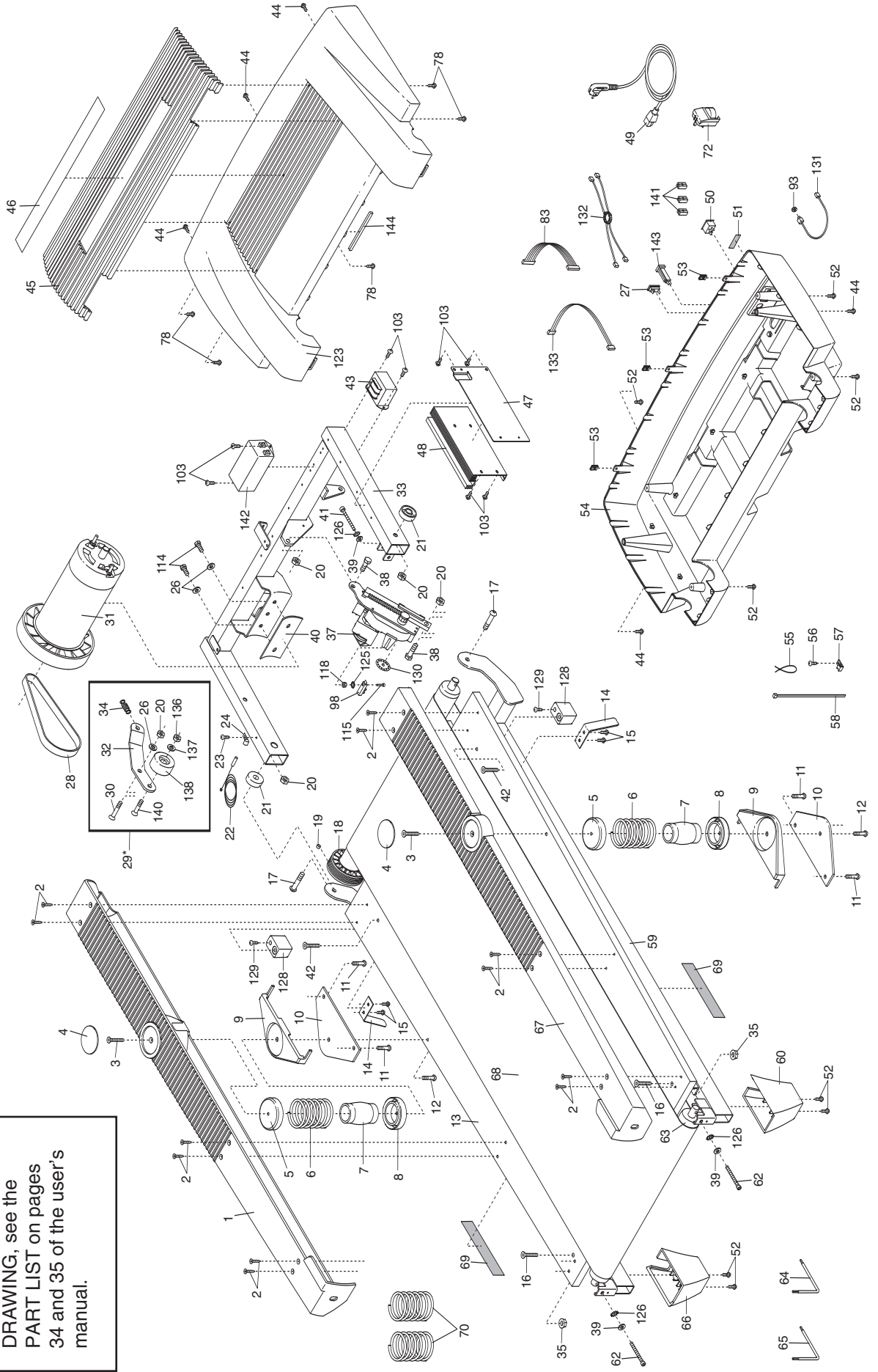

# EXPLODED DRAWING—Model No. GFTL13804.1

R0505A

