

EXPLODED DRAWING A

Model No. GGEL62910.5 R0213A

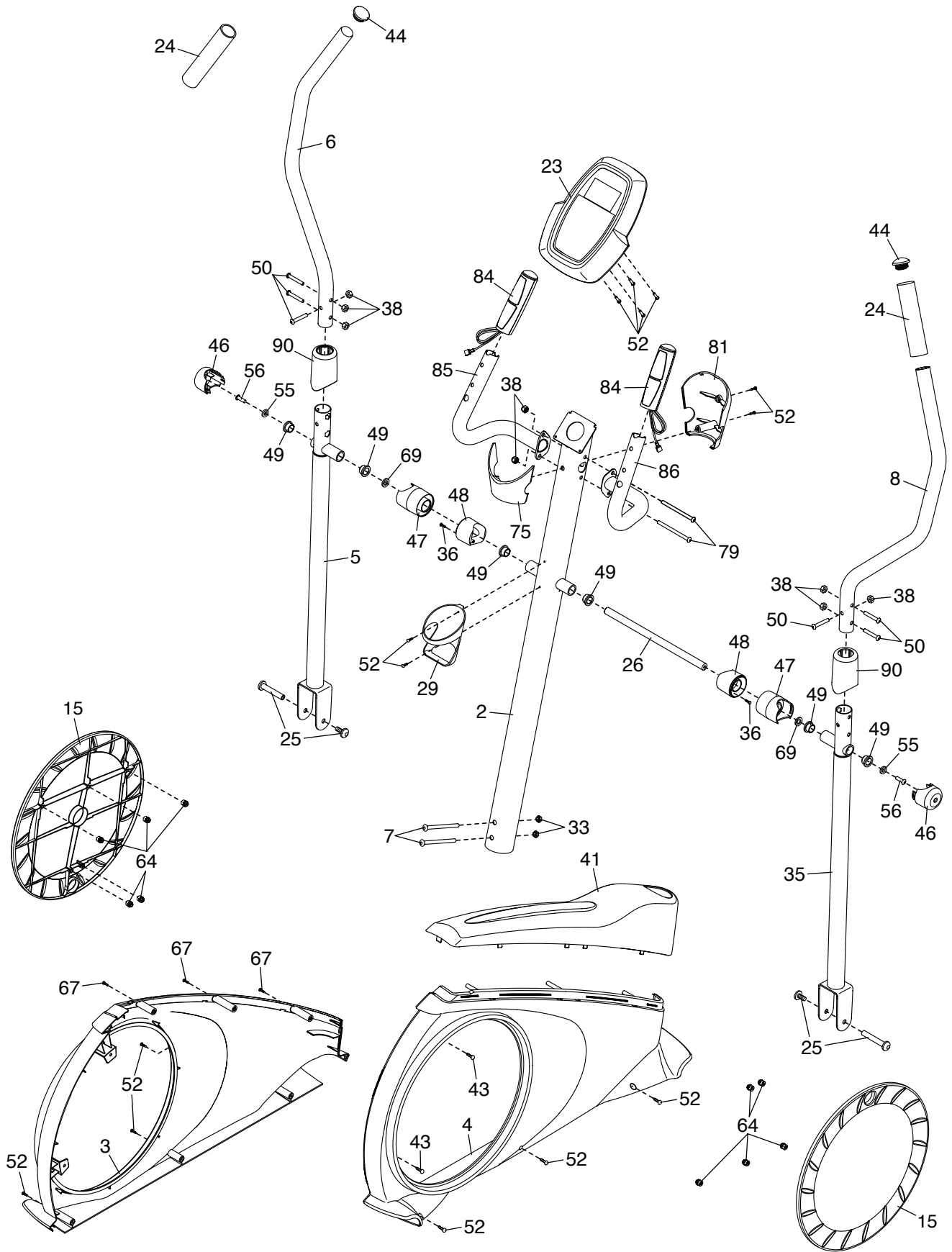

EXPLODED DRAWING B

Model No. GGEL62910.5 R0213A

