

EXPLODED DRAWING A

Model No. GGEL62910.6 R1012B

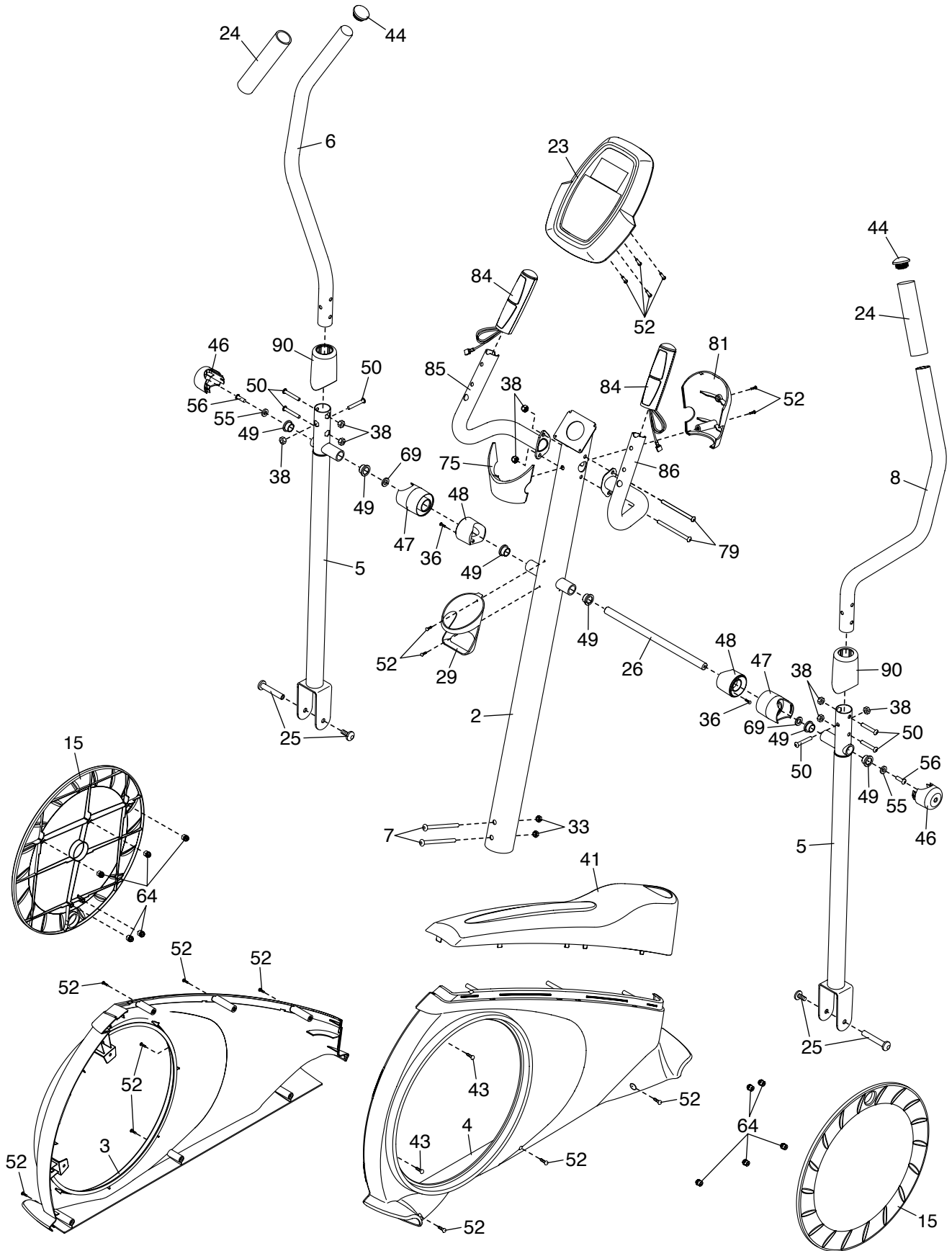

EXPLODED DRAWING B

Model No. GGEL62910.6 R1012B

