

EXPLODED DRAWING A

Model No. GGEL62915.0 R1016A

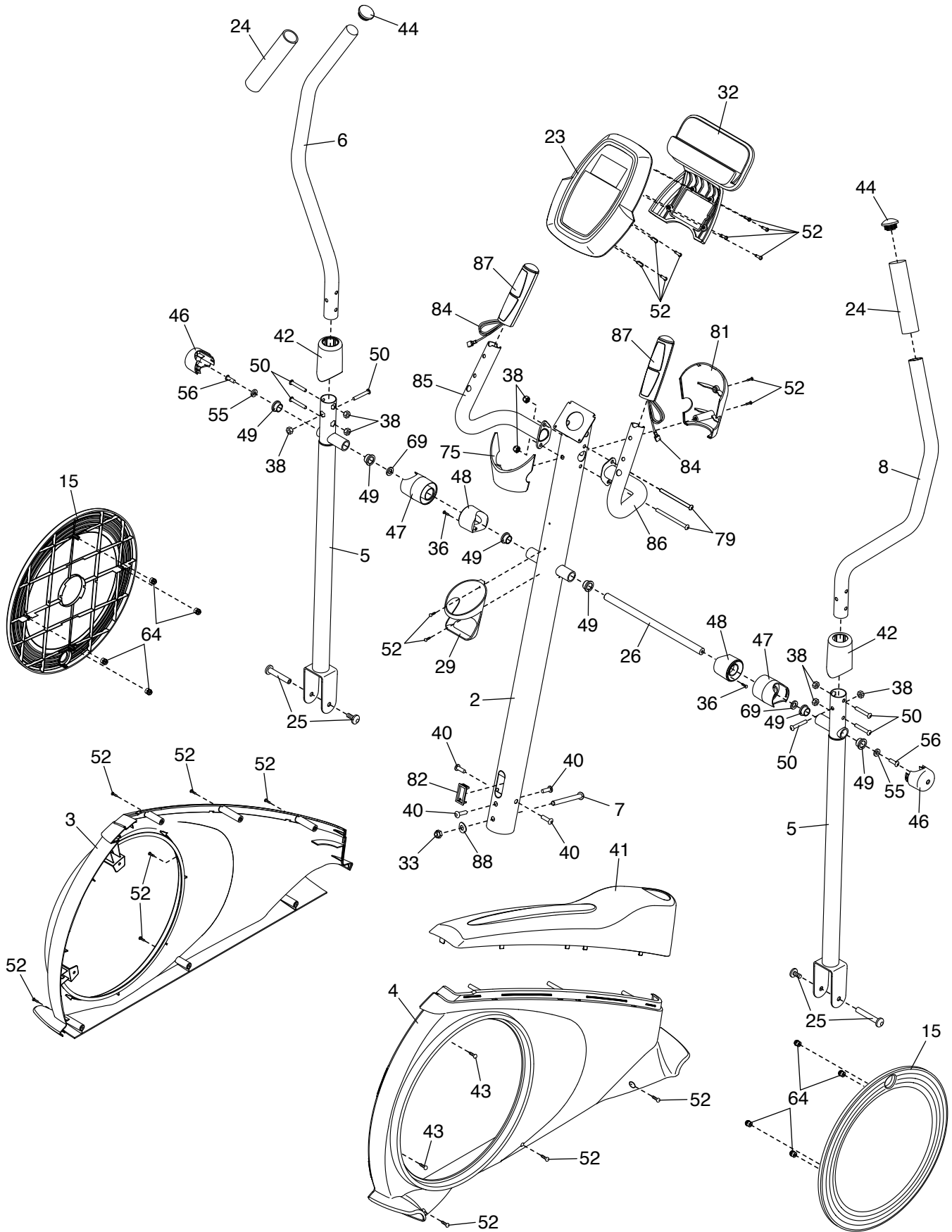

EXPLODED DRAWING B

Model No. GGEL62915.0 R1016A

