

EXPLODED DRAWING A

Model No. GGEL62915.1 R0715A

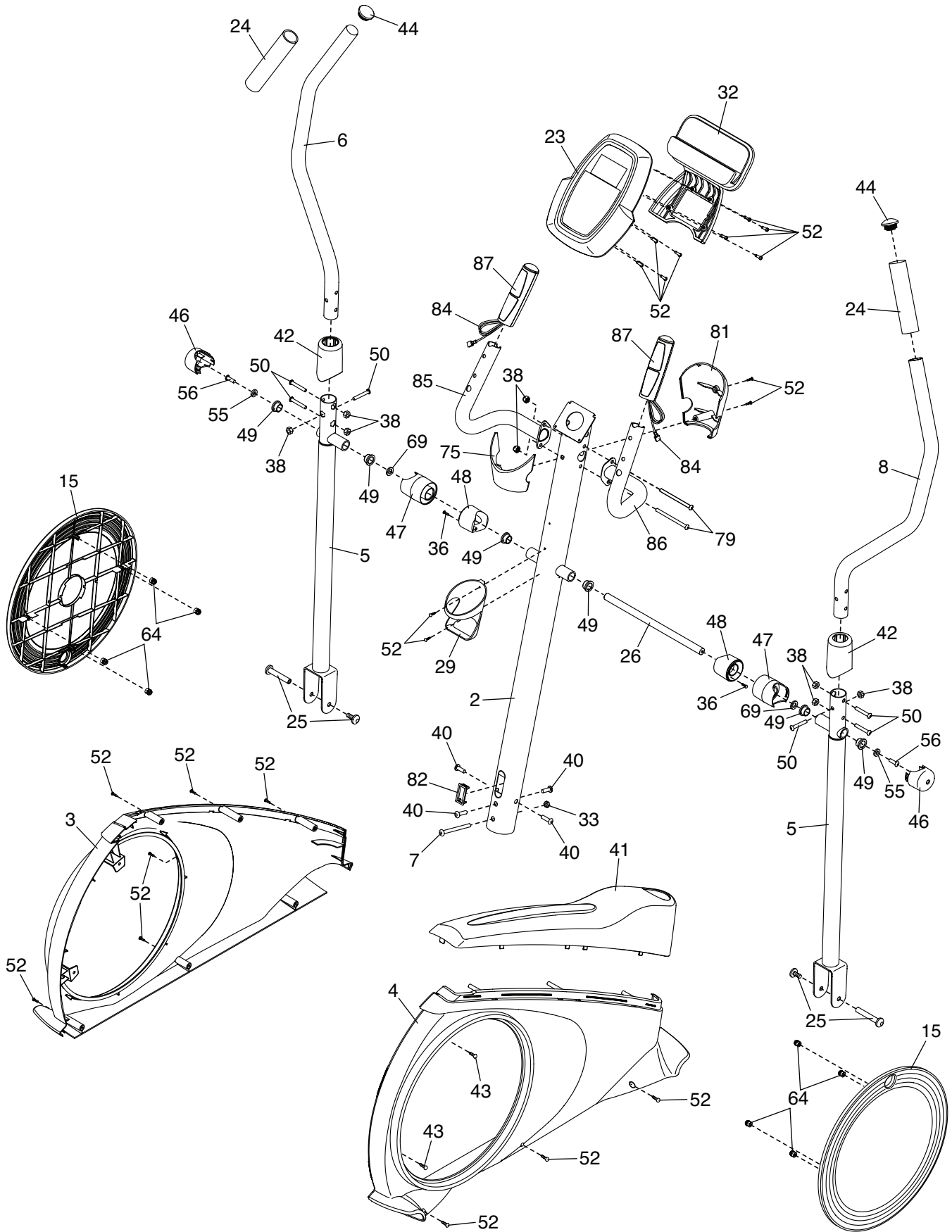

EXPLODED DRAWING B

Model No. GGEL62915.1 R0715A

