

EXPLODED DRAWING A

Model No. GGEL62915.2 R1116A

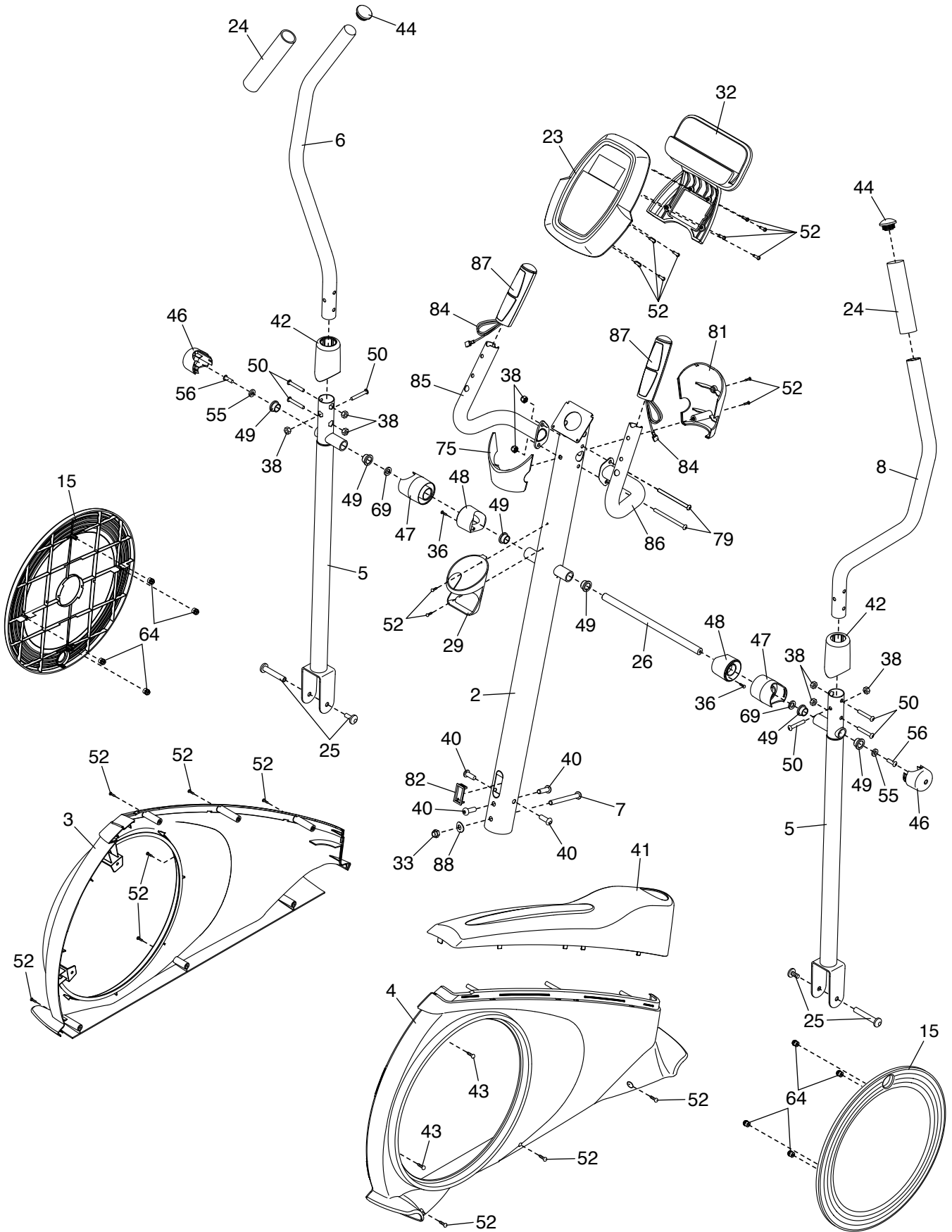

EXPLODED DRAWING B

Model No. GGEL62915.2 R1116A

