

EXPLODED DRAWING A

Model No. GGEL63812.2 R0713A

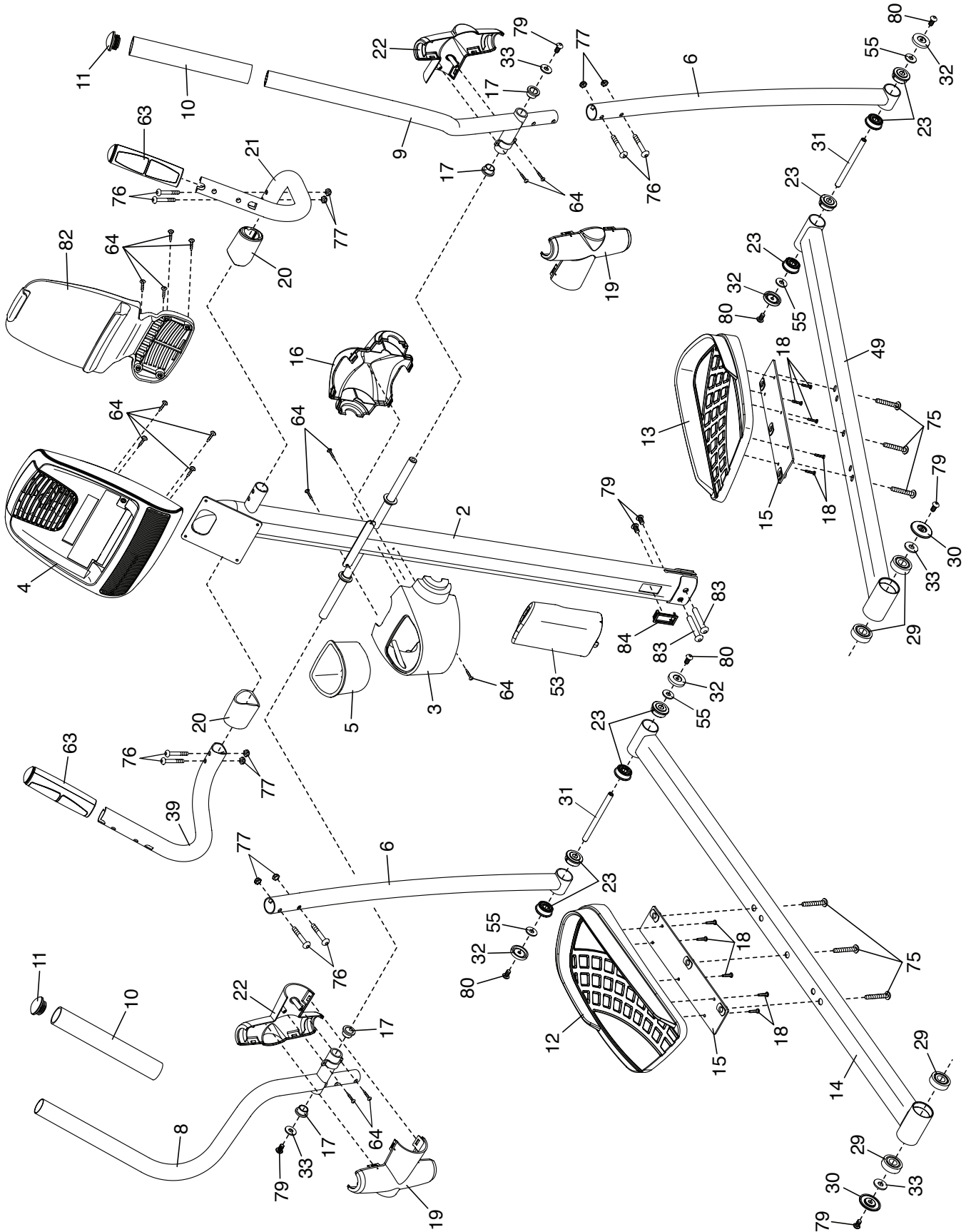

EXPLODED DRAWING B

Model No. GGEL63812.2 R0713A

