

EXPLODED DRAWING A

Model No. GGSY24613.3 R0317A

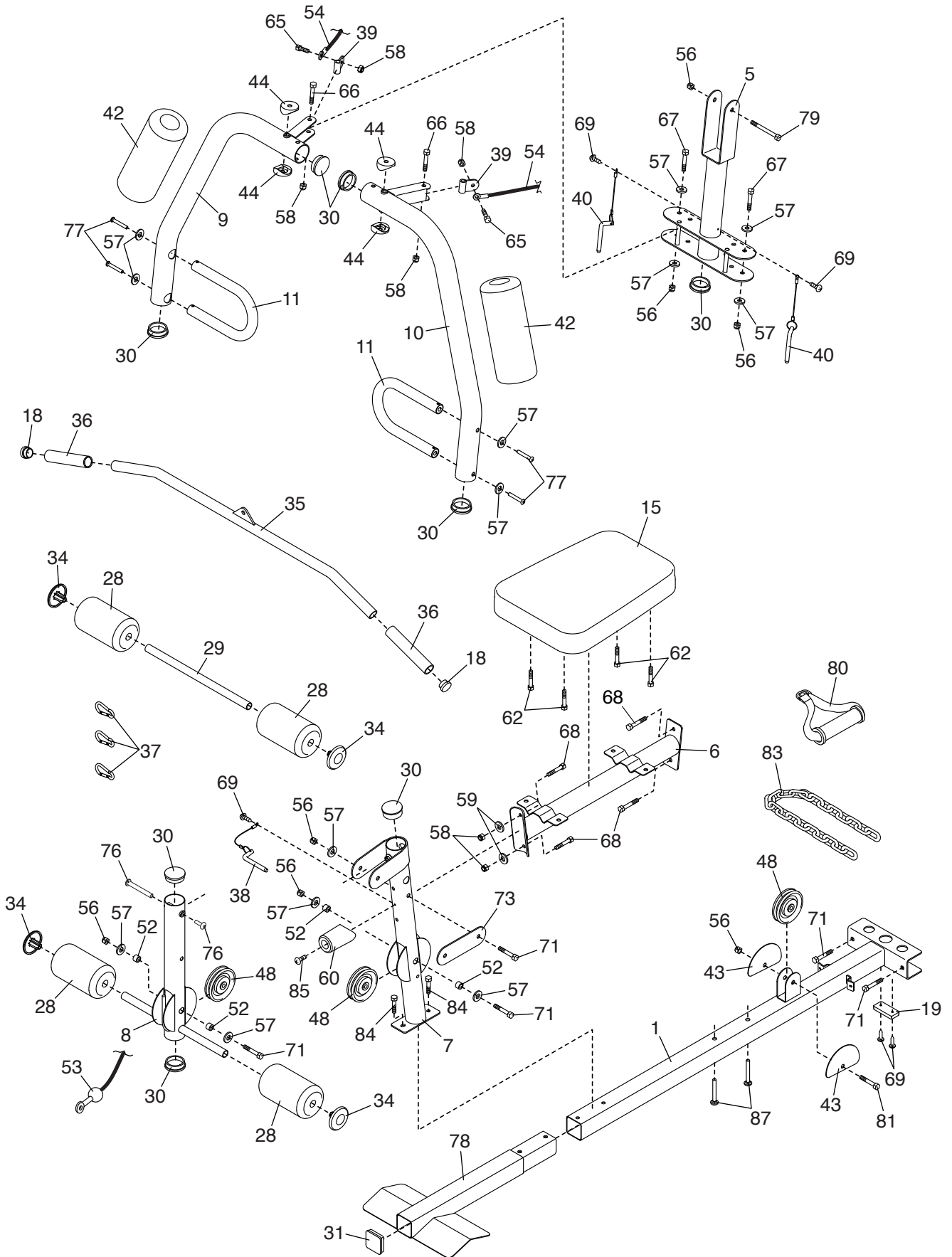

EXPLODED DRAWING B

Model No. GGSY24613.3 R0317A

