

# EXPLODED DRAWING A—Model No. GGTL07819.1

R0210A

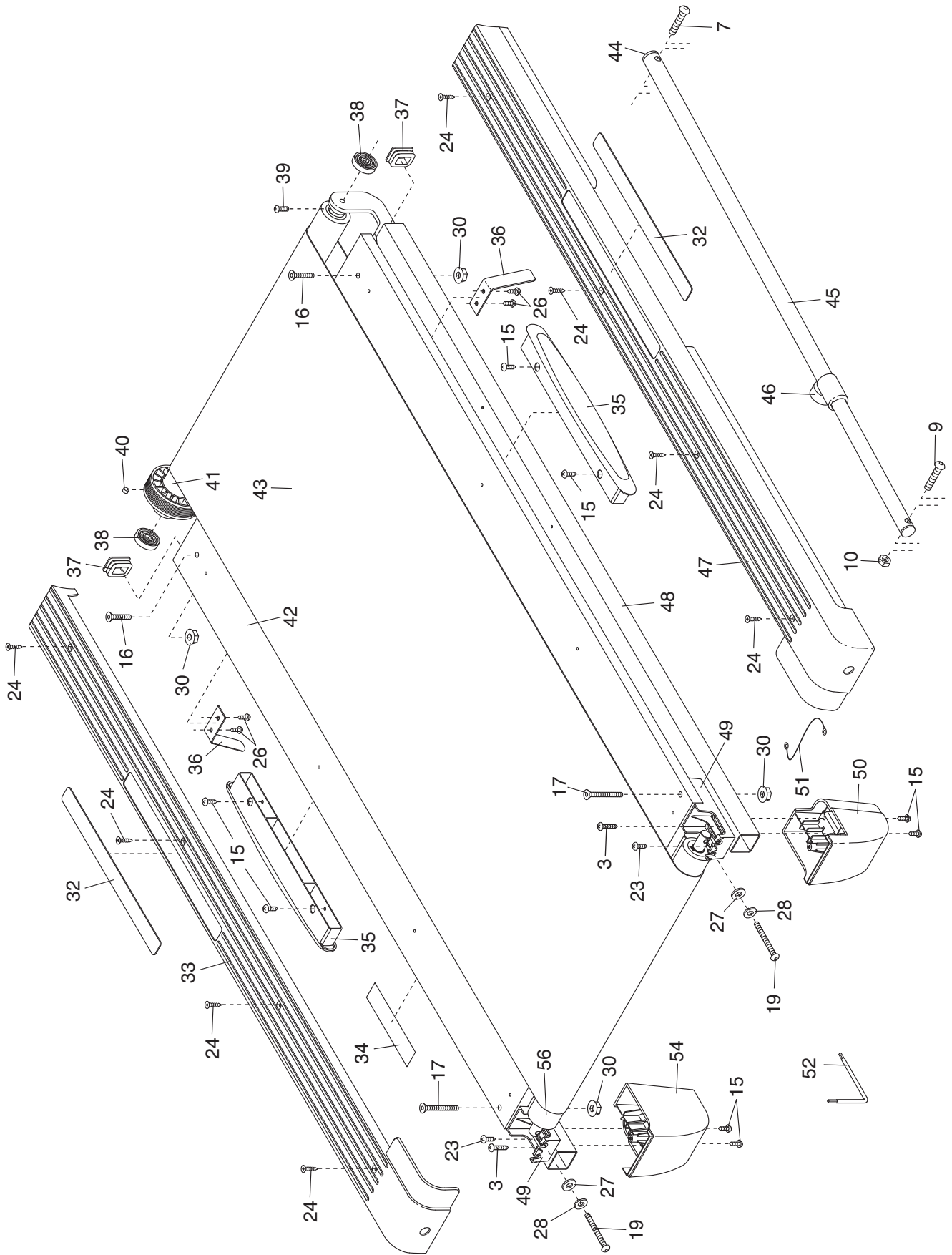

# EXPLODED DRAWING B—Model No. GGTL07819.1

R0210A

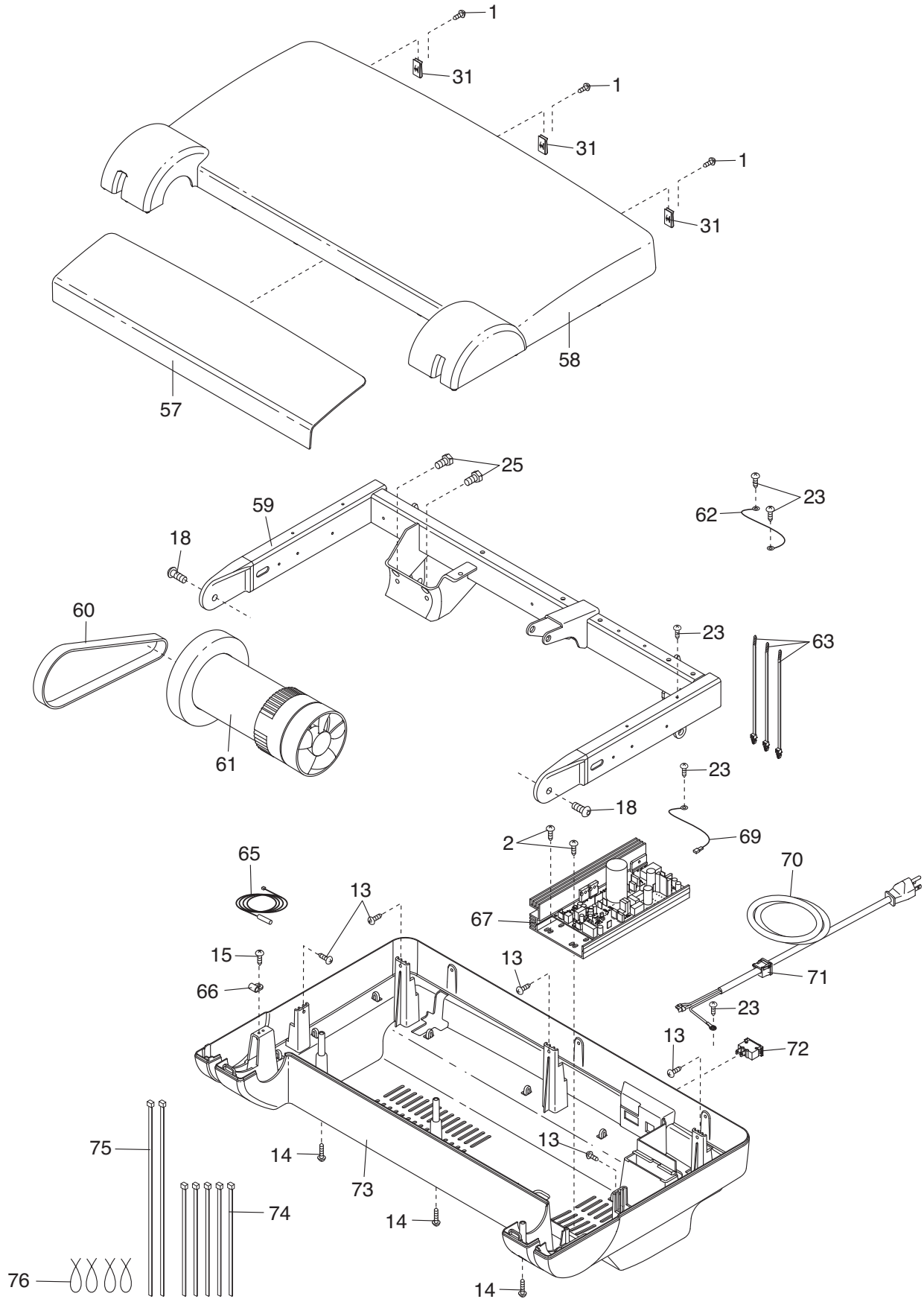



# EXPLODED DRAWING D—Model No. GGTL07819.1

R0210A

