

EXPLODED DRAWING A—Model No. GGTL15609.0

R0909A

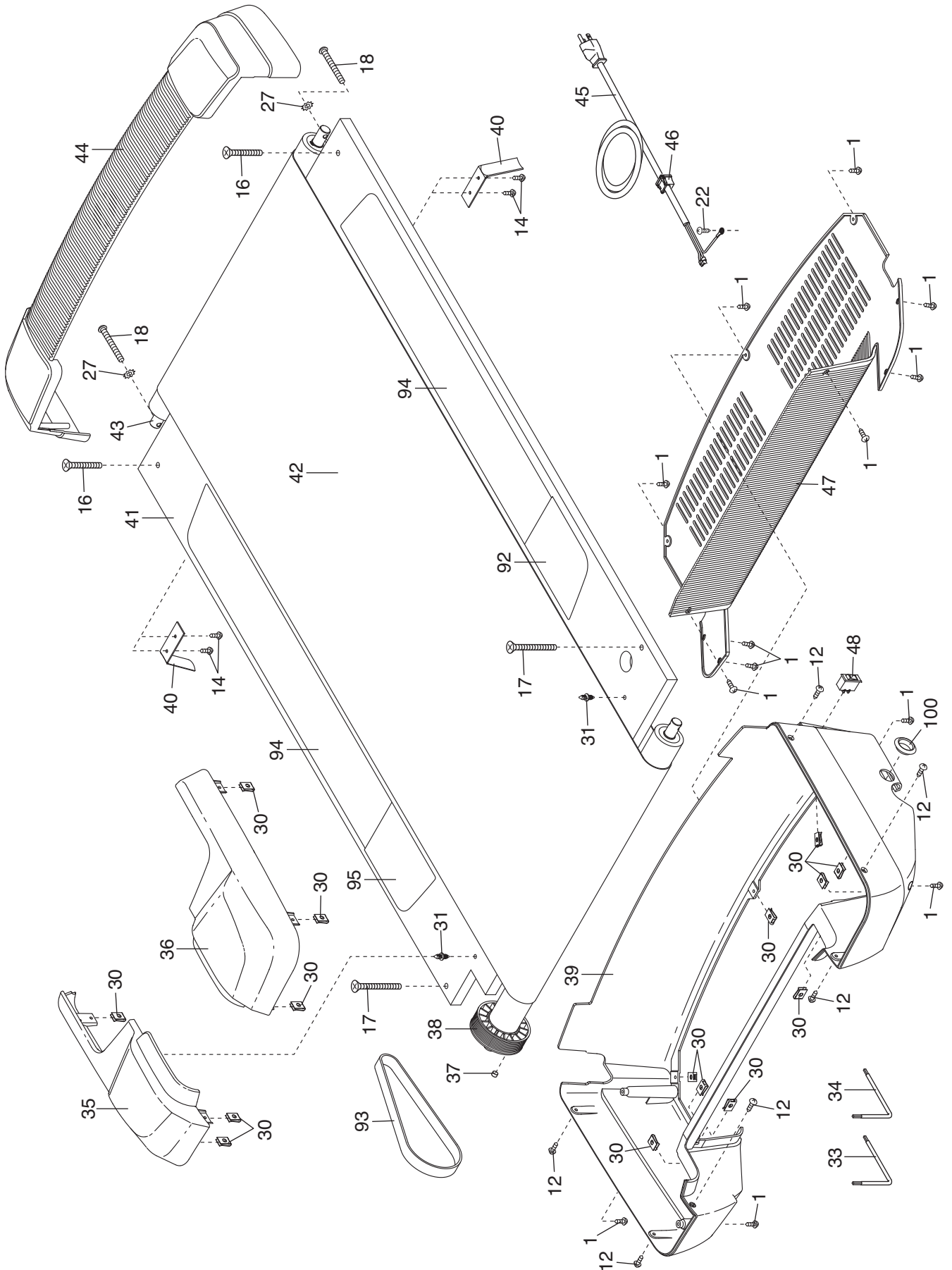

EXPLODED DRAWING B—Model No. GGTL15609.0

R0909A

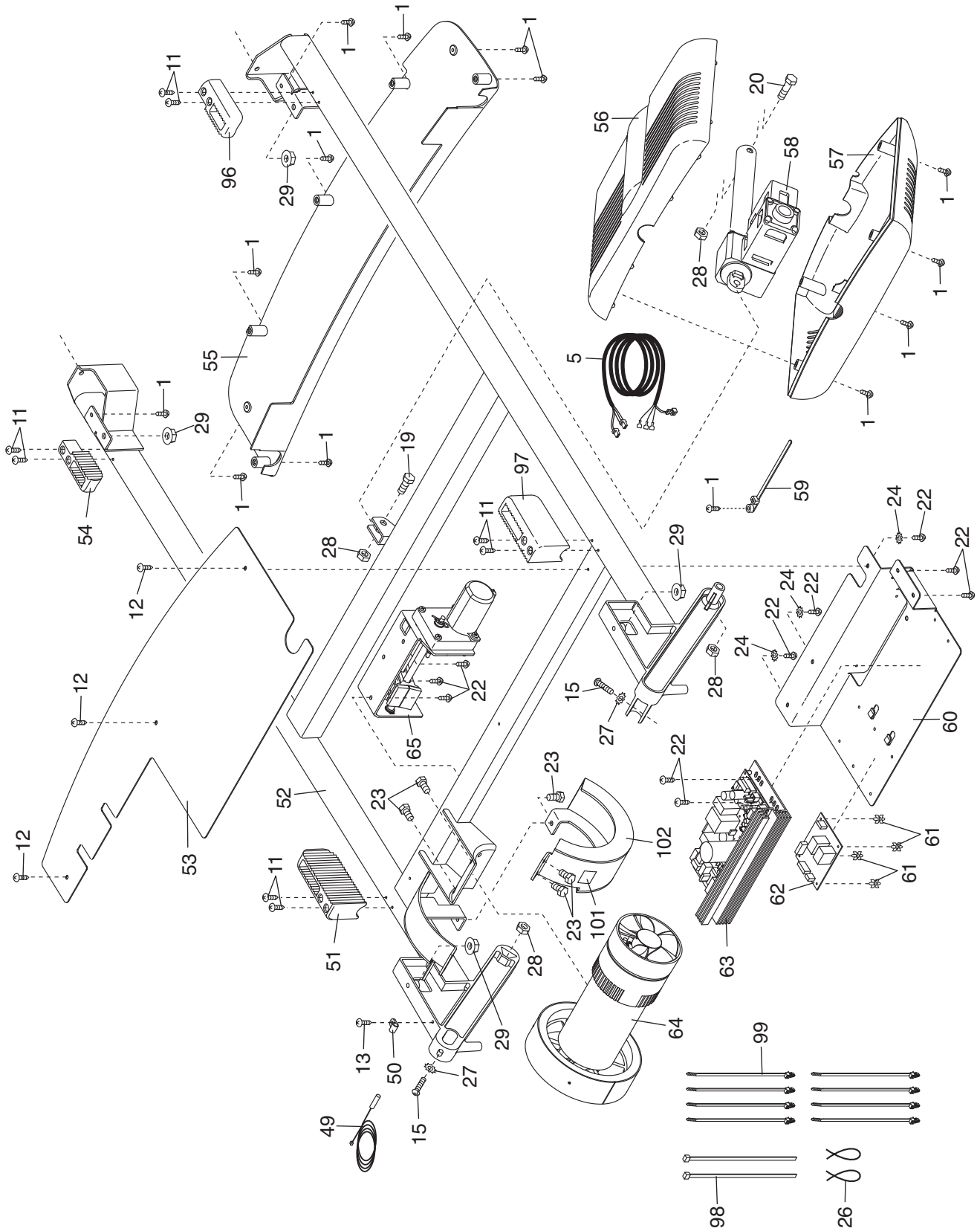

EXPLODED DRAWING D—Model No. GGTL15609.0

R0909A

