

EXPLODED DRAWING A

Model No. GGTL39610.4 R0812A

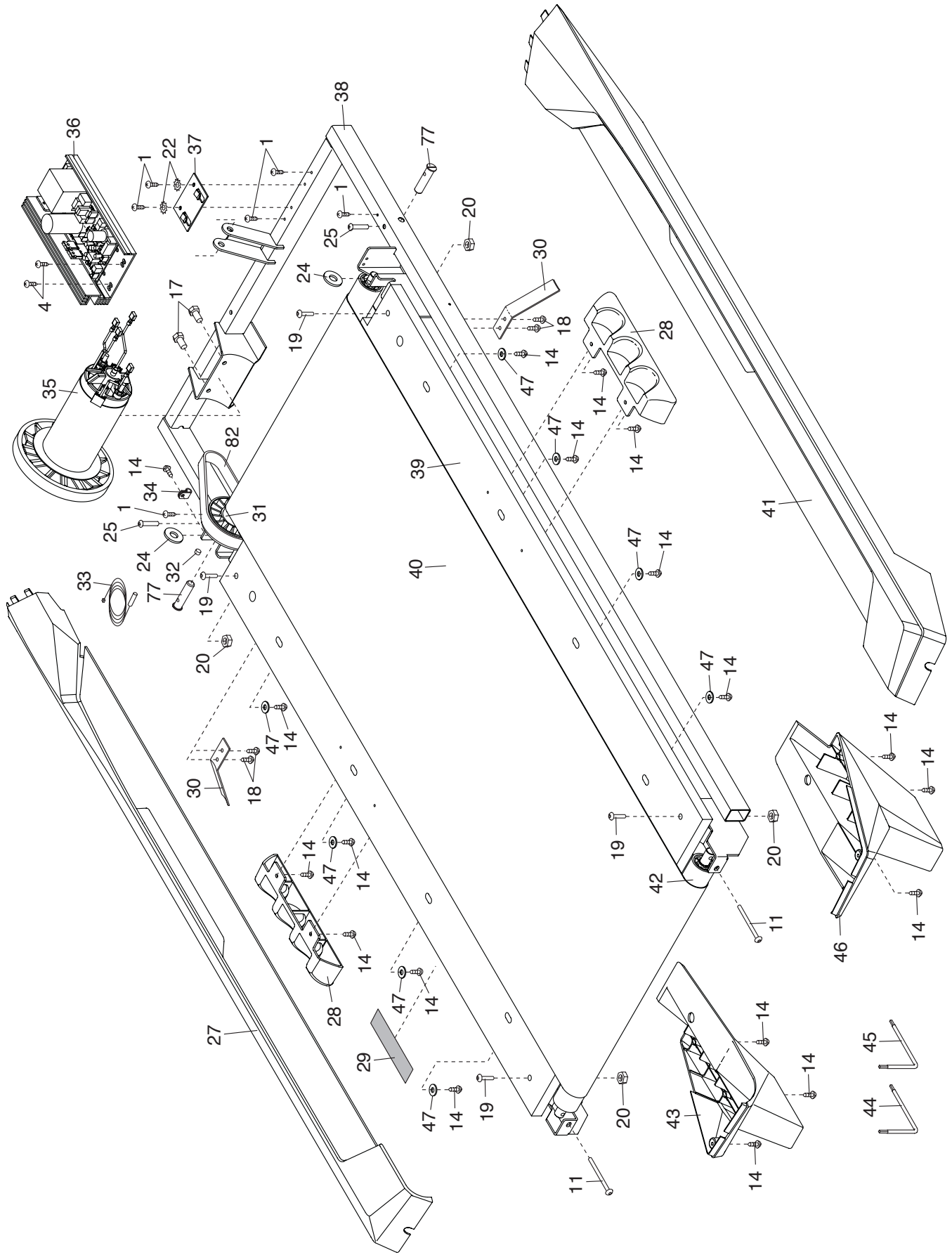

EXPLODED DRAWING B

Model No. GGTL39610.4 R0812A

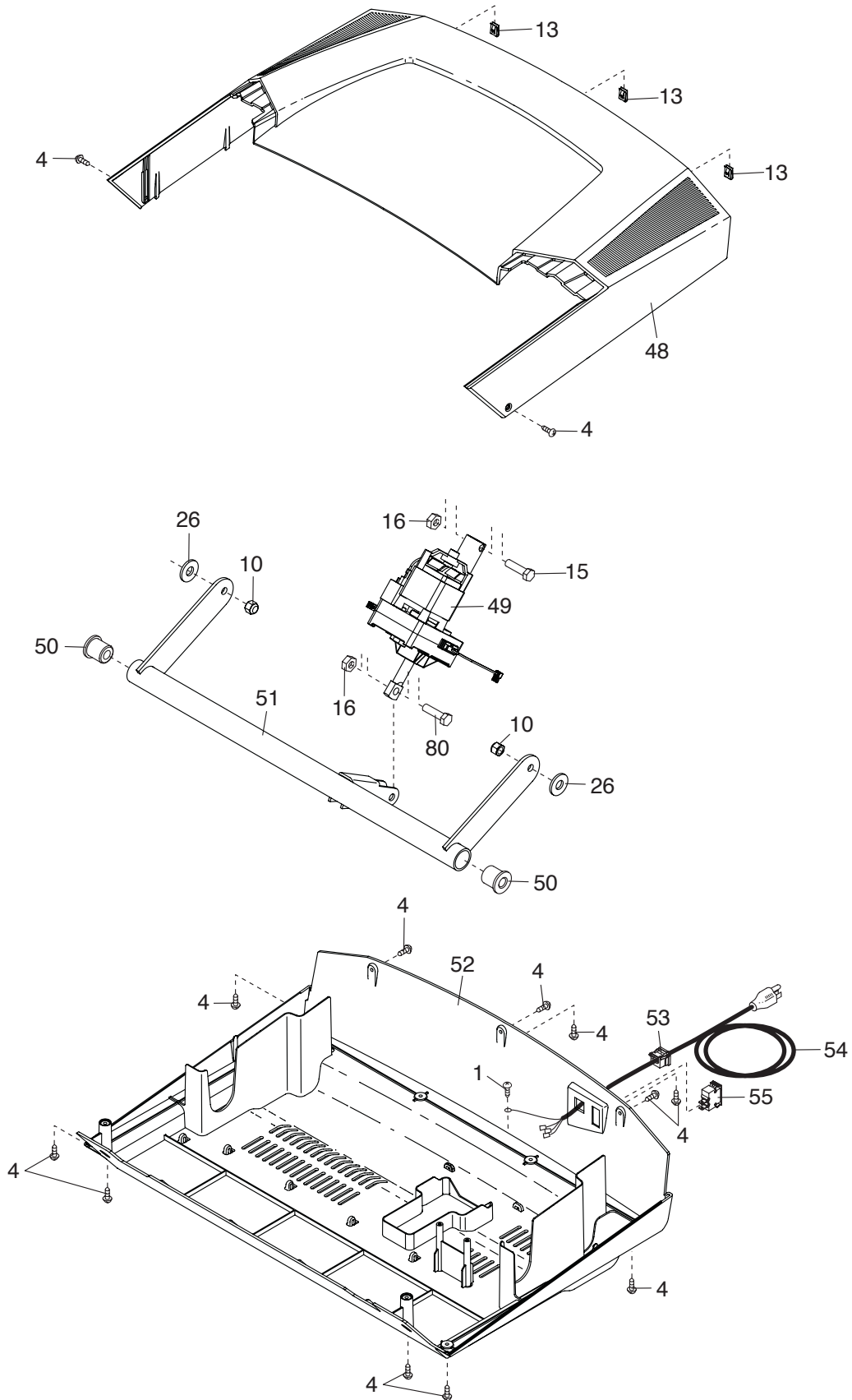

EXPLODED DRAWING C

Model No. GGTL39610.4 R0812A

